

Power & Energy Logger Model PEL 105

User Manual
ENGLISH



Measure up

www.aemc.com

 **AEMC**[®]
INSTRUMENTS
CHAUVIN ARNOUX GROUP

Copyright © Chauvin Arnoux®, Inc. d.b.a. AEMC® Instruments. All rights reserved.

No part of this documentation may be reproduced in any form or by any means (including electronic storage and retrieval or translation into any other language) without prior agreement and written consent from Chauvin Arnoux®, Inc., as governed by United States and International copyright laws.

Chauvin Arnoux®, Inc. d.b.a. AEMC® Instruments
15 Faraday Drive • Dover, NH 03820 USA
Tel: (800) 945-2362 or (603) 749-6434 • Fax: (603) 742-2346

This documentation is provided “as is,” without warranty of any kind, express, implied, or otherwise. Chauvin Arnoux®, Inc. has made every reasonable effort to ensure that this documentation is accurate; but does not warrant the accuracy or completeness of the text, graphics, or other information contained in this documentation. Chauvin Arnoux®, Inc. shall not be liable for any damages, special, indirect, incidental, or inconsequential; including (but not limited to) physical, emotional or monetary damages due to lost revenues or lost profits that may result from the use of this documentation, whether or not the user of the documentation has been advised of the possibility of such damages.

Chauvin Arnoux®, Inc, AEMC®, DataView®, AmpFlex®, and MiniFlex® are registered trademarks of AEMC® Instruments.

Thank you for purchasing a **Power Energy Logger Model PEL 105**.

For best results from your instrument and for your safety, read the enclosed operating instructions carefully and comply with the precautions for use. These products must be only used by qualified and trained users.



WARNING, risk of DANGER! The operator must refer to these instructions whenever this danger symbol appears.



Ethernet socket (RJ45).



Useful information or hint to read.



Main power supply input.



Equipment is protected by double insulation.



Ground/Earth.



USB socket.



SD Card.



The product has been declared recyclable after analysis of its life cycle in accordance with the ISO14040 standard.



The CE marking guarantees conformity with European directives and with regulations covering EMC.



The trash can with a line through it means that in the European Union, the product must undergo selective disposal for the recycling of electric and electronic material, in compliance with Directive WEEE 2002/96/EC.

Definition of Measurement Categories (CAT)

- **CAT IV** Measurement category IV corresponds to measurements taken at the source of low-voltage installations.
Example: power feeders, counters and protection devices.
- **CAT III** Measurement category III corresponds to measurements on building installations.
Example: distribution panel, circuit-breakers, machines or fixed industrial devices.
- **CAT II** Measurement category II corresponds to measurements taken on circuits directly connected to low-voltage installations.
Example: power supply to domestic electrical appliances and portable tools..

PRECAUTIONS FOR USE

These warnings are provided to ensure the safety of personnel. Please read and comply with these precautions.

- This instrument complies with safety standard IEC 61010-2-030, the leads comply with IEC 61010-031 for voltages of 1000V in measurement category III or 600V in measurement category IV, and the current sensors comply with IEC 61010-2-032.
- Carefully read and understand all required precautions when using this instrument. Failure to comply with these safety instructions can create a risk of electric shock, fire, and explosion; resulting in destruction of the instrument, injury to the user, and damage to the facility. If the instrument is used other than as specified in this manual, the protection provided by the instrument may be impaired.
- Do not use the instrument in an explosive atmosphere or in the presence of flammable gas or smoke.
- Do not use the instrument on electrical networks with a rated voltage or category higher than those listed for the instrument.
- Respect the maximum rated voltages and currents between terminals and in relation to ground/earth.
- Do not use the instrument if it seems to be damaged, incomplete, or poorly closed.
- Before each use, check the condition of the insulation of the leads, the instrument, and all accessories. Any insulation that appears damaged (even partially) must be taken out of service for repair or disposal.
- Use leads and accessories for voltage according to IEC 61010-031 and measurement categories at least equal to those of the instrument. An accessory with a lower category reduces the category of the combined instrument/accessory combination to that of the accessory.
- Respect the environmental conditions of use listed in this manual.
- Do not modify the instrument or replace components using substitute parts. Repairs and adjustments must be performed by AEMC Instruments.
- Use personal protection equipment when conditions require it.
- Keep hands and fingers away from unused terminals.

TABLE OF CONTENTS

Precautions for Use	iii
1. INTRODUCTION	6
1.1 Receiving Your Shipment	6
1.2 Ordering Information	6
1.2.1 Accessories.....	7
1.2.2 Replacement Parts.....	7
2. FEATURES.....	8
2.1 Description	8
2.2 Front Panel	9
2.3 Input Terminals	10
2.4 Button Functions.....	11
2.5 LCD Screens	12
2.6 LED Status Indicators	13
2.7 Installing the SD Card	14
3. SET UP & CONFIGURATION	15
3.1 Powering the Instrument	15
3.1.1 Phase Voltage Power	15
3.2 Charging the Battery	16
3.3 Turning the Instrument ON/OFF	16
3.3.1 Turning the Instrument ON.....	16
3.3.2 Turning the Instrument OFF	16
3.4 Bluetooth Enabling and Disabling	17
3.5 Wi-Fi Enabling and Disabling	17
3.6 Configuring the PEL 105	17
3.6.1 Configuration Mode	18
3.6.2 Selecting the Hookup	19
3.6.3 Selecting Nominal Current and Voltage	20
3.6.4 Setting the Aggregation Period for a Recording	22
3.7 Viewing Instrument Information.....	22
4. OPERATION.....	23
4.1 Hooking Up to the Distribution System.....	23
4.1.1 Single-Phase 2-Wire (1P-2W)	24
4.1.2 Single-Phase 3-Wire (1P-3W)	25
4.1.3 3-Phase 3-Wire Δ (2 current probes) (3P-3W Δ 2)	25
4.1.4 3-Phase 3-Wire Δ (3 current probes) (3P-3W Δ 3)	25
4.1.5 3-Phase 3-Wire Open Δ (2 current probes) (3P-3WO2)	26
4.1.6 3-Phase 3-Wire Open Δ (3 current probes) (3P-3WO3)	26
4.1.7 3-Phase 3-Wire Y (2 current probes) (3P-3WY2)	26

4.1.8	3-Phase 3-Wire Y (3 current probes) (3P-3WY3)	27
4.1.9	3-Phase 3-Wire Δ Balanced (1 current probe) (3P3W Δ b)	27
4.1.10	3-Phase 4-Wire Y (3 current probes) (3P-4WY)	27
4.1.11	3-Phase 4-Wire Y Balanced (3P-4WYb)	28
4.1.12	3-Phase 4-Wire Y 2½ Element (3P-4WY2)	28
4.1.13	3-Phase 4-Wire Δ (3P-4W Δ)	28
4.1.14	3-Phase 4-Wire Open Δ (3P-4WO)	29
4.1.15	DC 2-Wire (dC-2W)	29
4.1.16	DC 3-Wire (dC-3W)	29
4.1.17	DC 4-Wire (dC-4W)	30
4.2	Viewing Data	30
4.2.1	Measurement Mode	31
4.2.1.1	1-Phase 2-Wire (1P-2W)	31
4.2.1.2	1-Phase 3-Wire (1P-3W)	32
4.2.1.3	3-Phase 3-Wire Unbalanced	33
4.2.1.4	3-Phase 3-Wire Δ Balanced (3P-3W Δ b)	35
4.2.1.5	3-Phase 4-Wire Unbalanced	36
4.2.1.6	3-Phase 4-Wire Y Balanced (3P-4WYb)	38
4.2.1.7	DC 2-Wire (dC-2W)	39
4.2.1.8	DC 3-Wire (dC-3W)	40
4.2.1.9	DC 4-Wire (dC-4W)	41
4.2.2	Energy Mode	42
4.2.2.1	AC Energy Screens	42
4.2.2.2	DC Energy Screens	45
4.2.3	Harmonics Mode	46
4.2.3.1	1-Phase 2-Wire (1P-2W)	46
4.2.3.2	1-Phase 3-Wire (1P-3W)	46
4.2.3.3	3-Phase 3-Wire Unbalanced	47
4.2.3.4	3-Phase 3-Wire Δ Balanced (3P-3W Δ b)	48
4.2.3.5	3-Phase 4-Wire Unbalanced	48
4.2.3.6	3-Phase 4-Wire Balanced (3P-4WYb)	49
4.2.4	Maximum Mode	50
4.2.4.1	1-Phase 2-Wire (1P-2W)	50
4.2.4.2	1-Phase 3-Wire (1P-3W)	51
4.2.4.3	3-Phase 3-Wire	52
4.2.4.4	3-Phase 4-Wire	53

5. RECORDING DATA 55

5.1	Recording Session Overview	55
5.2	Starting and Stopping a Recording	56

6. DATAVIEW® & PEL CONTROL PANEL..... 57

6.1	Installing DataView	58
6.2	The PEL Control Panel	60
6.3	Connecting to the Computer	61
6.3.1	USB	61
6.3.2	Bluetooth	61

6.3.3	Wi-Fi Direct Connection.....	62
6.3.4	Point-to-Point Ethernet Cable.....	62
6.3.5	Ethernet Network via LAN or Wi-Fi.....	63
6.3.6	Network via IRD Server.....	63
6.4	Setting Date and Time.....	63

7. SPECIFICATIONS 64

7.1	Reference Conditions.....	64
7.2	Electrical Specifications.....	64
7.2.1	Voltage Inputs.....	64
7.2.2	Current Inputs.....	64
7.2.3	Measurement Ranges.....	65
7.2.3.1	Measurement Specifications at 50/60Hz.....	65
7.2.3.2	Measurement Specifications at 400Hz.....	66
7.2.3.3	Measurement Specifications for DC.....	67
7.2.3.4	Temperature.....	68
7.2.3.5	Common Mode Rejection.....	68
7.2.4	Current Probe Specifications.....	68
7.2.4.1	Current Probes with 1V Output.....	68
7.2.4.2	AmpFlex®/MiniFlex®.....	69
7.3	Communication.....	69
7.4	Power Consumption.....	70
7.5	Physical.....	70
7.6	Environmental.....	71
7.7	Electrical Safety.....	71
7.8	Electromagnetic Compatibility.....	71
7.9	Memory Card.....	71
7.10	Current Probes and Sensors.....	71
7.10.1	AmpFlex® Model A196-24-BK.....	72
7.10.2	MiniFlex® Model MA193.....	72
7.10.3	Model J93.....	73
7.10.4	Model MR193-BK.....	73
7.10.5	Model MN93-BK.....	74
7.10.6	Model SR193-BK.....	74
7.10.7	Model MN193-BK.....	75
7.10.8	Model SL261.....	75
7.11	Voltage Test Leads.....	76

8. MAINTENANCE & TROUBLESHOOTING 77

8.1	Maintenance.....	77
8.1.1	Erasing and Upgrading Memory.....	77
8.1.2	Upgrading Firmware.....	78
8.1.3	Battery Maintenance.....	79
8.1.4	Cleaning the Instrument.....	79

8.2	Troubleshooting.....	79
8.2.1	Instrument Does Not Turn ON.....	79
8.2.2	Instrument Turns ON but Does Not Function	80
8.2.3	Cannot Configure the Instrument.....	80
8.2.4	Recording Sessions Do Not Start.....	80
8.2.5	Recording Sessions End Prematurely.....	80
8.2.6	Cannot Connect to a Computer.....	81
8.2.7	Cannot Turn OFF the Instrument	81

APPENDIX A: THEORY OF OPERATION 82

A.1	Sampling.....	82
A.1.1	Locking the Sampling Frequency.....	84
A.1.2	AC/DC.....	83
A.1.3	Neutral Current Measurement	83
A.1.4	“200ms” Quantities.....	83
A.1.5	“1s” Quantities (one second)	83
A.1.6	Aggregation	83
A.1.7	Minimum and Maximum	83
A.1.8	Energy Calculations	84
A.2	Phase Sequence.....	84
A.2.1	Current Phase Sequence	84
A.2.2	Voltage Phase Sequence	85
A.2.3	Current vs Voltage Phase Sequence	86

APPENDIX B: MEASUREMENT QUANTITIES 87

APPENDIX C: POLE MOUNTING..... 95

GLOSSARY 97

Repair and Calibration..... 100

Technical and Sales Assistance..... 100

Limited Warranty 101

Warranty Repairs 101

1. INTRODUCTION

1.1 Receiving Your Shipment

Upon receiving your PEL 105 product package, ensure the contents are consistent with the packing list. Notify your distributor of any missing items. If the equipment appears to be damaged, file a claim immediately with the carrier and notify your distributor at once, providing a detailed description. Save the damaged packing container to substantiate your claim.

1.2 Ordering Information

- Power & Energy Logger Model PEL 105 (no sensors)..... **Cat. #2137.57**
 Power & Energy Logger Model PEL 105 (with four A196-24-BK sensors)..... **Cat. #2137.59**

Shipping Contents:



(1) Power & Energy Logger
 Model PEL 105
Cat. #2137.57 or Cat. #2137.59



(1) Large Classic Tool Bag
Cat. #2133.73



(5) Black Test Leads and Alligator Clips
Cat. #2140.73*
 (*Replacement comes in Qty of 1)



(1) Power Adapter 110/240V
 w/ Power Cord
Cat. #5000.19



Accessory Pouch
Cat. #2137.80



(4) 24" AmpFlex® Model A196-24-BK
Cat. #2140.75
(Only Shipped with PEL 105 Cat. #2137.59)



(1) USB SD-Card Adapter
Cat. #5000.45

Also Includes:

- 4 GB USB Drive (DataView/User Manual)
- 9.6V NiMh Battery - installed
- 8 GB SD-Card - installed
- High Voltage Warning/Caution Card



(12) Color-coded
 ID Markers
Cat. #2140.45



(1) 5 ft USB Cable
Cat. #2140.46

1.2.1 Accessories

USB cable, A/B 10 ft (3m)	Cat. #2136.80
Pole Mounting Kit.....	Cat. #2137.82
AC/DC Current Probe Model J93.....	Cat. #2140.49
AC/DC Current Probe Model MR193-BK.....	Cat. #2140.28
AC Current Probe Model MN93-BK.....	Cat. #2140.32
AC Current Probe Model SR193-BK.....	Cat. #2140.33
AmpFlex® Sensor 36” Model 193-36-BK	Cat. #2140.35
AC Current Probe Model MN193-BK.....	Cat. #2140.36
MiniFlex® Current Sensor 10” Model MA193-10-BK	Cat. #2140.48
MiniFlex® Current Sensor 14” Model MA193-14-BK	Cat. #2140.50
AC/DC Current Probe Model SL261*	Cat. #1201.51
*BNC Adapter for Current Probe Model SL261.....	Cat. #2140.40

1.2.2 Replacement Parts

Large Classic Tool Bag.....	Cat. #2133.73
Accessory Pouch	Cat. #2137.80
Set of 12 Color-coded Input ID Markers	Cat. #2140.45
USB Cable A/B, 5 ft (1.5m).....	Cat. #2140.46
Lead – One 10 ft (3m) Black Lead (Waterproof cap) {Rated 1000V CAT IV} & One Black Alligator Clip {Rated 1000V CAT IV, 15A, UL}.....	Cat. #2140.73
AmpFlex® Sensor Model A196-24-BK (Waterproof).....	Cat. #2140.75
Adapter – Replacement Power Adapter 110V/230V with US Power Cord	Cat. #5000.19
USB SD-card Adapter.....	Cat. #5000.45

DataView® Software and Instrument Firmware Updates
Available at www.aemc.com

PEL Android App Available on the Google Play Store at
<https://play.google.com/store/apps/details?id=com.aemc.pel&hl=en>

2. FEATURES

2.1 Description

The Power & Energy Logger Model PEL 105 provides all the necessary functions and features for recording power/energy data for most 50Hz, 60Hz, 400Hz, and DC distribution systems worldwide. The instrument is designed for full outdoor or indoor use, resistant to both water (IP67) and sunlight (UL746C f1).

The instrument measures phase-to-phase (U_{12} , U_{23} , U_{31}), phase-to-neutral (V_1 , V_2 , V_3) and neutral-to-ground/earth (VNE) voltage up to 1000V in measurement Category IV, with pollution degree 4 (IEC 61010). The instrument also measures phase (I_1 , I_2 , I_3) and neutral (I_n) current, using a variety of external current probes/sensors.

A total of 17 types of electrical hookups are supported, including single-phase, split-phase, 3-phase 3-wire, 3-phase 4-wire, open, and DC 2-, 3- and 4-wire.

This measurement data is then used to calculate:

- Power (VA, W, and var)
- Energy (VAh, Wh (source and load), and varh (4 quadrants))
- Power Factor (PF), $\cos \varphi$, and $\tan \varphi$
- Crest Factor
- Total Harmonic Distortion (THD) for voltages and currents
- Harmonics from the fundamental signal up to the 50th order for 50/60Hz voltages and currents
- Frequency measurements
- RMS and DC measurements @ 128 samples/cycle (each phase simultaneously)

The instrument can be connected to a computer running DataView data analysis software via Wi-Fi, Bluetooth®, network, USB, or point-to-point Ethernet cable. The DataView PEL on the computer can view real-time data, start and stop a recording session, download previously recorded sessions stored on the instrument for further analysis and report generation, and set configuration variables.

Other features include:

- Measurements are sampled every 200ms and 1s, and can be aggregated from 200ms to 1 hour and stored in a removable SD card or SDHC card (up to 32GB). This provides high data resolution and detail, especially for detecting short-term electrical phenomena. For 50 and 60Hz systems, 200ms aggregation is calculated every 10 or 12 cycles, respectively. For 400Hz systems, aggregation is performed every 80 cycles.
- Aggregated harmonics represent the minimum and maximum values of aggregated quantities for a given duration. These values can be displayed on the LCD front panel display, or on the computer via the DataView PEL Control Panel
- The instrument can be powered from line voltage terminals or an AC/DC power adapter.

2.2 Front Panel

The instrument front panel interface includes LED status indicators, screens that appear on the LCD, and buttons to navigate these screens, select options, and enter data.

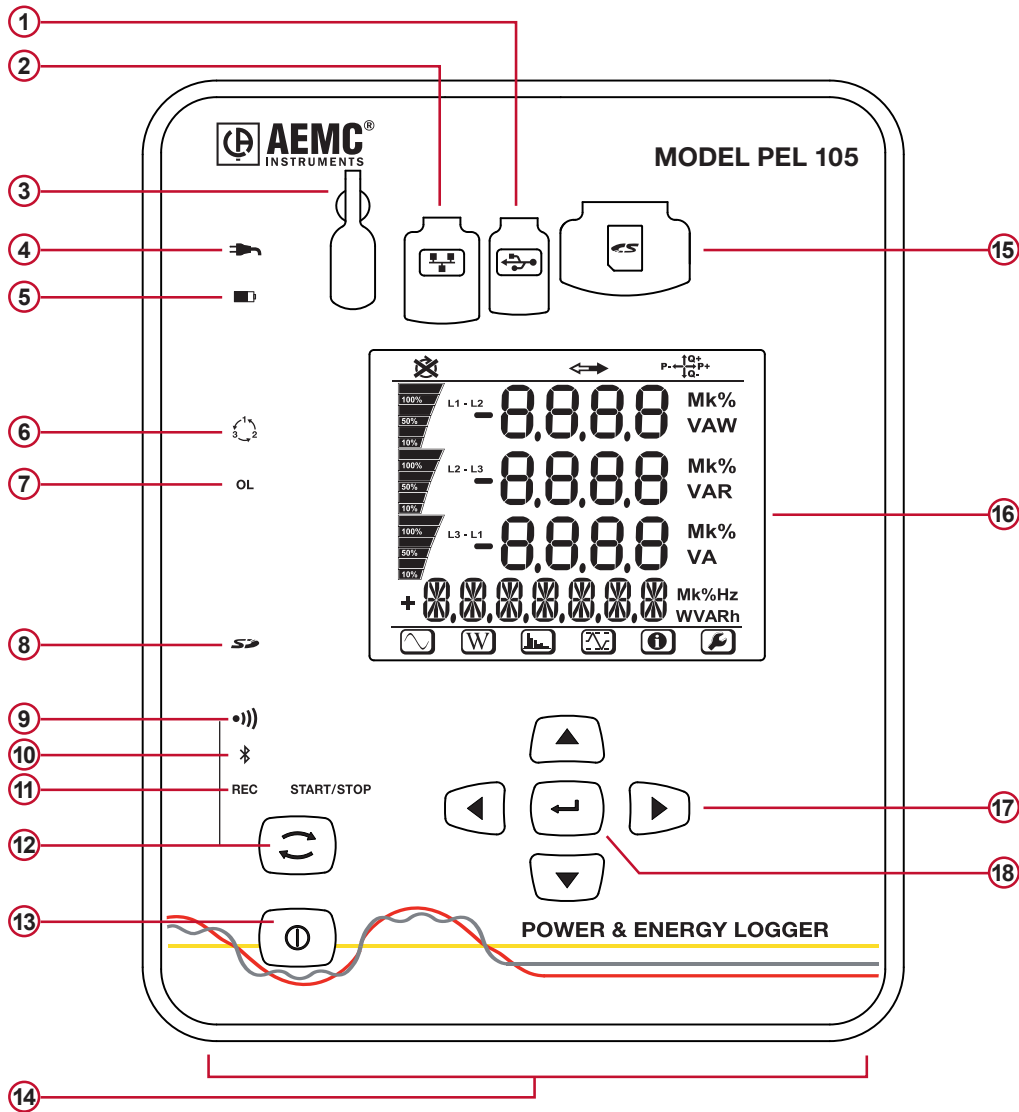











Figure 1



- | | |
|-----------------------|---|
| 1. USB Port | 10. Bluetooth LED |
| 2. Ethernet Port | 11. Recording LED |
| 3. Power Input | 12. Control Button |
| 4. External Power LED | 13. Power Button |
| 5. Battery LED | 14. Input Terminals |
| 6. Phase Sequence LED | 15. SD Card Slot |
| 7. Overload LED | 16. LCD Screen |
| 8. SD Card LED | 17. Directional Buttons (Up, Down, Left, Right) |
| 9. Wi-Fi LED | 18. Enter button |

2.4 Button Functions

BUTTON	DESCRIPTION
	<p>Power</p> <ul style="list-style-type: none"> - Turns the instrument ON or OFF when running on battery power. The instrument cannot be turned OFF via the Power button while it is running on external AC or line input power. - Glows green when the instrument is running on power supplied by the line voltage terminal input (see § 3.3.1). - When not glowing, indicates the line power feature is enabled but the instrument is running on external AC or battery power. - Blinks red when the line power is disabled.
	<p>Control (Start/Stop)</p> <ul style="list-style-type: none"> - Starts or stops a data recording session. - Enables or disables Bluetooth. - Enables or disables Wi-Fi. - When pressed and held down simultaneously with the Power button  for 2 seconds, enables/disables the line power feature.
	<p>Enter</p> <ul style="list-style-type: none"> - In Configuration mode, selects a parameter for editing. This initiates the edit mode (the selected parameter blinks). Pressing this button again saves the modification. - In Measurement mode, displays additional information for some measurement screens. - In Energy mode, displays partial energy data. - In all other modes, this button is inactive.
	<p>Left and Right</p> <ul style="list-style-type: none"> - Changes modes. Note that this functionality is “circular” – pressing the Right button  while in Configuration mode navigates to the top-level Measurement screen; pressing the Left button  while in Measurement mode goes to the top-level Configuration screen. - In edit mode, these buttons select editable parameters.
	<p>Up and Down</p> <ul style="list-style-type: none"> - When editing parameters in Configuration mode, these buttons cycle through the available options for the selected setting. - In all other modes, these buttons navigate through the individual screens.



NOTE: In this manual, the  symbol indicates when you need to press a button to perform a task.

For example,   represents “press the Control  button.”

2.5 LCD Screens

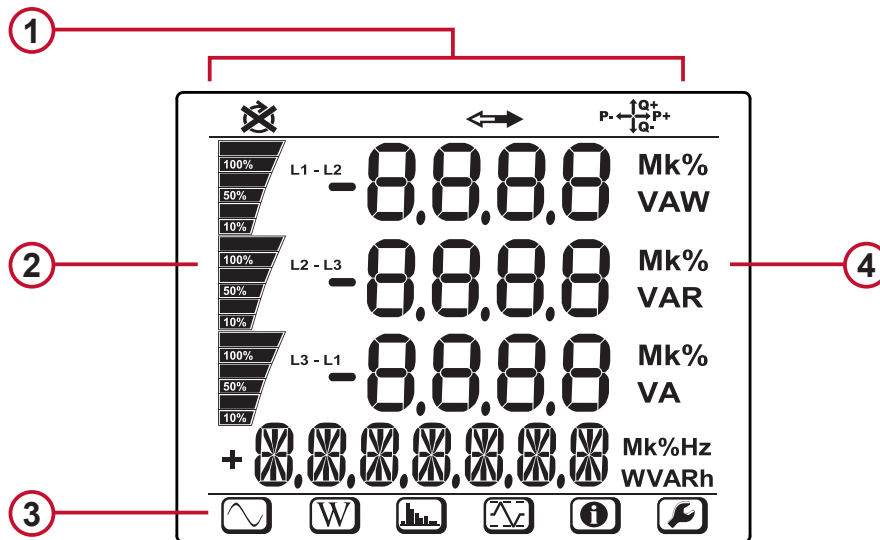

Figure 4

1. Status icons.
2. Bargraphs. These indicate the percentage (0% to 100%) of full range or full load as defined through the DataView PEL Control Panel.
3. Mode icons that control the data and information displayed (see the table below).
4. Units of measure.







The Status & Mode icons on the top and bottom of the display indicate the following information:

ICON	DESCRIPTION
	Indicates (1) the phase sequence may be incorrect, or (2) there is a missing phase. This icon only appears in Measurement mode.
	Indicates measurement data is available for recording. The absence of this icon may indicate an internal issue with the instrument.
	Indicates the current power quadrant.
	Real-time Measurement Mode: Displays the measurement values for voltage, current, power, frequency, power factor, and tangent angle.
	Power and Energy Mode: Displays the energy values for reactive energy, apparent energy, and kilowatt hour.
	Harmonics Mode: Displays harmonics for current and voltage.
	Max Mode: Displays the maximum values for the measurement and energy values.
	Information Mode: Displays electrical hookup and other instrument-related information (these screens are read-only).
	Configuration Mode: Displays screens containing user-selectable configuration settings and options.

NOTE: As a screen saver feature, when the instrument is ON and there is no activity on the user interface for approximately three minutes, the LCD automatically enters Backlight Standby mode. In this mode, measurements and recordings stay active but the LCD backlight turns OFF. To restore the backlight, press any navigation button.

2.6 LED Status Indicators

On the left side of the front panel is a vertical row of LEDs (see Figure 1) which provide the following information:

LED	STATUS
	<p>External Power (Green)</p> <p>ON: Instrument is currently running on external AC power. OFF: Instrument is running on battery or phase power.</p>
	<p>Battery (Yellow/Red)</p> <p>ON: - Steady yellow: Battery is actively charging. - Blinking yellow (once per second): Battery is recovering from a full discharge. - Blinking red (twice per second): Battery is low and there is no external AC power connected.</p> <p>OFF: Battery is fully charged.</p>
	<p>Phase Sequence (Red)</p> <p>ON: Blinks once per second to indicate one of the following:</p> <ul style="list-style-type: none"> - The phase difference between current phases is greater than 30° relative to the expected difference (120° for three-phase and 180° for two-phase). - The phase difference between the voltage phases is greater than 10° relative to the expected difference. - The phase difference between the current phase and voltage phase for each phase is greater than 60°. <p>OFF: Phase rotation order is correct.</p>
	<p>Overload (Red)</p> <p>ON: At least one input is overloaded, or current inputs are mismatched. OFF: No input overload.</p>
	<p>SD-Card (Red/Green/Orange)</p> <p>ON: - Steady red: SD card is locked, unrecognized, or not present. - Blinking red: SD card is initializing. - Blinking orange: SD card is full. - Steady green: SD card is present, recognized, and unlocked. - Blinking green: SD card will be full before the end of the in-progress or pending recording.</p>
	<p>Wi-Fi (Green)</p> <p>ON: - Steady: Wi-Fi is enabled but not currently transmitting - Blinking: Wi-Fi is enabled and transmitting.</p> <p>OFF: Wi-Fi is disabled.</p>
	<p>Bluetooth (Blue)</p> <p>ON: - Steady: Bluetooth is enabled but not currently transmitting. - Blinking: Bluetooth is enabled and transmitting.</p> <p>OFF: Bluetooth is disabled.</p>
REC	<p>Recording (Green)</p> <p>ON: - Blinks twice every 5 seconds when recording. - Blinks once every 5 seconds when not recording.</p>

In addition, the Power  button (described in § 2.4) glows green when the instrument is running on phase voltage power, and blinks red once per second when phase voltage power is disabled. (See also § 3.1.1.)

2.7 Installing the SD Card

Data recording sessions are stored in the included 8GB SD card, which also accepts FAT32 SDHC cards up to 32GB capacity. If the SD card is unformatted, you will need to format it before use. Formatting can be done through the DataView PEL Control Panel.

To install the SD card:

1. Locate the card slot on the front panel (see Item 15 in Figure 1).
2. Ensure that the write-protect sliding tab on the card is in the “unlock” position (towards the metal contacts).
3. Insert the SD card into the slot, with the metal contacts facing up (towards the top of the instrument).
4. Press the SD card into the slot until it clicks in place.
5. Press the attached cap into the card slot to ensure waterproofing.
6. If the SD Card is not formatted, the  LED glows red. To format the installed card, do the following:
 - (a) Open the PEL Control Panel.
 - (b) Click Instrument in the menu bar and select Configure.
 - (c) Click Format SD-Card in the General tab of the Configure Instrument dialog box.
 - (d) Click Yes to confirm.

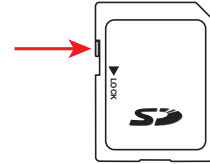

When the card is installed and ready for use, the  LED glows steady green. To remove a card, press down on it until the card unclicks. It will pop up, allowing you to pull it from the slot.

3. SET UP & CONFIGURATION

Before using the instrument for the first time, ensure the battery is fully charged (see § 3.2) and that the instrument is ready for operation. You must also configure the instrument for the hookup type appropriate for the electrical distribution system under test.

 **NOTE:** Before changing any setup or configuration setting, ensure that no recording is active or pending on the instrument.



3.1 Powering the Instrument

The instrument can operate on three different sources of power:





- External power provided by plugging into an AC outlet with the AC adapter. When you connect the instrument to an AC outlet, it automatically turns ON. The instrument will always run on external AC power when plugged in, even if phase power and/or battery power are also available.
- Phase power provided through line voltage at the terminals. If AC wall power is disconnected, the instrument runs on phase voltage power if it is available and enabled.
- Battery backup power. If neither external AC power nor phase voltage is available, the instrument runs on battery power.

3.1.1 Phase Voltage Power

Powering the instrument through phase voltage power requires no special preparation or equipment; simply connect two voltage leads to an AC power line, connect the leads to the instrument using any available voltage terminals (see § 3), and unplug the external AC adapter if connected. By default, the instrument will immediately begin drawing phase power from the line.

The Power  button glows green when the instrument is running on phase power. In this situation, the instrument cannot be turned OFF via the  button.

Note that you cannot power the instrument from a DC network. Also note that if the AC adapter is plugged in, the instrument will use this source instead of phase power.

You can disable the phase power feature by pressing  and  simultaneously for two seconds. When you do this,  blinks red once every two seconds, indicating the instrument cannot run on phase power. Pressing  and  simultaneously for two seconds re-enables this feature. You can also disable and enable this feature through the DataView PEL Control Panel (see § 6).

3.2 Charging the Battery

The PEL 105 is equipped with a NiMH battery, which provides power in the event of a disruption in the phase power or external AC power. Before the first use, start by fully charging the battery.

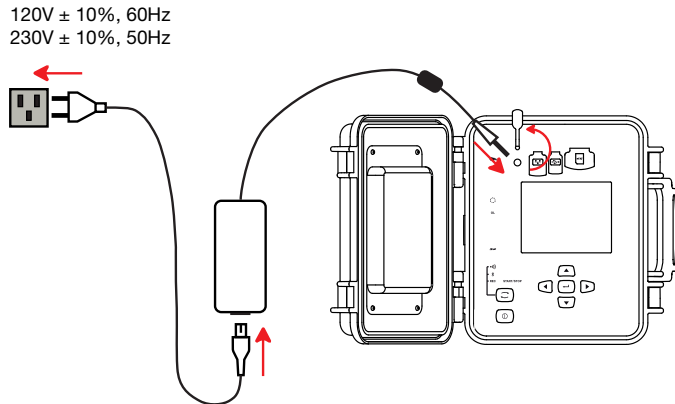





Figure 5

- Connect the supplied power cord to the instrument and AC power. The device will automatically turn ON.
- The  LED lights; it will go out only when the battery is fully charged.
- A low battery charging takes approximately 5 hours.

Fully charging the battery may take up to 5 hours if the battery is at or near complete discharge. If after 5 hours the  LED does not turn OFF, operate the instrument on battery power until the battery runs low, and then repeat the charging procedure.

In normal operation, a fully charged battery will provide power for up to one hour before requiring another charging session (although this period may be shorter if the instrument is actively using Bluetooth or Wi-Fi to communicate). The  LED glows red when the battery is low and in need of charging.







3.3 Turning the Instrument ON/OFF

3.3.1 Turning the Instrument ON

- **On AC power or phase voltage power**, the instrument automatically turns ON when you connect it.
- **On battery power**, you must press  for two seconds to turn ON the instrument.

3.3.2 Turning the Instrument OFF







The procedure for turning OFF the instrument depends upon the power source. First check to see whether or not a recording is scheduled or in progress (the **REC** LED blinks twice every five seconds when a recording is active). If so, either stop the recording, or wait until it is finished. Then do one of the following:

- **AC power** (indicated when the  LED is lit): Unplug the AC power adapter, and then press  for two seconds. When all LEDs light up simultaneously, release .
- **Phase voltage power** (indicated when  glows green): Disconnect the voltage terminal leads from the instrument, then press  for two seconds and release it when all LEDs light up simultaneously.
- **Battery power**: Press  for two seconds and release it when all LEDs light up simultaneously.

In addition, the instrument includes a feature that automatically turns it OFF after a period of inactivity when running on battery power. This period, which is defined through the PEL Control Panel, can be set to 3, 10, or 15 minutes. It can also be disabled.

3.4 Bluetooth Enabling and Disabling





To communicate via a Bluetooth connection, check the Bluetooth  LED on the instrument. If this is OFF, Bluetooth is disabled. To enable Bluetooth:

1. Press and hold down . After a few moments the Recording **REC** LED lights up; continue to press the button until the  LED lights up.
2. Release ; when you do the  LED lights and remains lit, indicating Bluetooth is now enabled.
3. To disable Bluetooth, press  until the  LED lights up; then release the button. The  LED will turn OFF.

In addition to enabling and disabling Bluetooth, the PEL Control Panel allows you to change the instrument's Bluetooth name, enable Bluetooth password-protection, and select whether or not the instrument is visible to other Bluetooth devices.

3.5 Wi-Fi Enabling and Disabling

The procedure for enabling Wi-Fi is similar to the process for enabling Bluetooth:

1. Check the Wi-Fi  LED. If this is OFF, press and hold down  until the  LED lights up.
2. To disable Wi-Fi, press  until the  LED lights up; then release the button.



You can also enable and disable Wi-Fi through the PEL Control Panel. In addition, you can change the SSID (Service Set Identifier) name, and define a Wi-Fi password via the PEL Control Panel. (Note that the default Wi-Fi password is printed on a label placed inside the instrument's cover.)

3.6 Configuring the PEL 105

Before you can use the instrument for the first time, you must set a number of configuration variables. Full setup and configuration is performed through a computer running the DataView PEL Control Panel (see § 6). This includes setting the instrument's time and date (§ 6.4).

In addition, a subset of configuration settings can be performed directly on the instrument via its LCD interface, including:

- Select the hookup for the electrical distribution system under test
- Set voltage and current ratios appropriate for the connected probes or sensors
- Set the aggregation period for a recording session
- Review instrument settings, such as date and time

Before you can perform any configuration on the instrument, the Control  button must be enabled. This button is enabled and disabled through the PEL Control Panel. When this button is disabled, Configuration  mode displays the word LOCK, and no configuration screens are available. (Note that LOCK also appears if the PEL Control Panel is actively configuring the instrument.) If  is disabled, enable it as follows:

1. Open the PEL Control Panel.
2. Ensure that the instrument is connected by checking its status in the PEL Network frame. If not, reconnect it by highlighting the instrument, selecting Instrument in the menu bar, and clicking Reconnect Instrument.
3. Select the instrument, and click Instrument in the menu bar.
4. Select Configure. This displays the Configure Instrument dialog box.
5. De-select the checkbox "Lock out the Control button on the instrument front panel."
6. Click OK to save the change.

Consult the PEL Control Panel Help system for assistance in completing the preceding steps.

3.6.1 Configuration Mode

Configuration mode enables you to change several settings, including:

- Hookup type
- Primary and secondary nominal voltage
- Primary nominal current
- Primary nominal neutral current
- Aggregation period

To enter Configuration mode, press either ◀ or ▶ until the Configuration  icon is highlighted. Note that there are several situations that prevent you from making changes in Configuration mode:

- The instrument is currently being configured by the PEL Control Panel.
- Local configuration is locked (disabled) through an option in the PEL Control Panel. This prevents configuration even when the instrument is disconnected from the Control Panel.
- A recording session is in progress.

If any of these situations is in effect, the word LOCK appears on the screen:

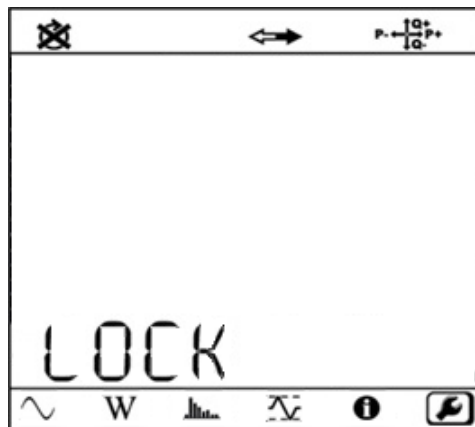

Figure 6

Otherwise, the Hookup configuration screen appears:

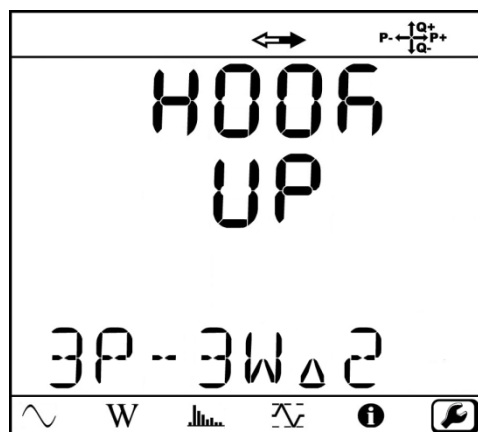

Figure 7

This is the top-level screen in Configuration mode, and serves as the starting point for all configuration tasks.

3.6.2 Selecting the Hookup

The Hookup configuration screen lets you select the type of hookup for the electrical distribution system under measurement. This must be the same physical hookup as the probes/sensors (see § 4).

To select the hookup:

1. Press Enter (↵). The displayed hookup type blinks, indicating you are now in edit mode.
2. Press ▲ or ▼ to navigate through the available hookup types.

For example, in the following table:







- ▲ displays the preceding (next higher) hookup.



- ▼ displays the following (next lower) hookup.

Options are:

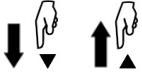
OPTION	HOOKUP TYPE	TO CHANGE, PRESS:
dC-4W	DC 4-wire	
dC-3W	DC 3-wire	
dC-2W	DC 2-wire	
3P-4WO	3-phase 4-wire Open Δ	
3P-3WO3	3-phase 3-wire Open Δ (3 current probes)	
3P-3WO2	3-phase 3-wire Open Δ (2 current probes)	
3P-3WY3	3-phase 3-wire Y (3 current probes)	
3P-3WY2	3-phase 3-wire Y (2 current probes).	
3P-4WΔ	3-phase 4-wire Δ	
3P-4WY2	3-phase 4-wire Y 2½	
3P-4WYb	3-phase 4-wire Y balanced (fixed, voltage measurement)	
3P-4WY	3-phase 4-wire Y	
3P-3WΔb	3-phase 3-wire Δ balanced	

3P-3W Δ 3	3-phase 3-wire Δ (3 current probes)	
3P-3W Δ 2	3-phase 3-wire Δ (2 current probes)	
1P-3W	1-phase 3-wire (split phase)	
1P-2W	1-phase 2-wire	

Note that this list is not cyclical; pressing \blacktriangledown while 1P-2W is displayed (or pressing \blacktriangle while dC-4W is displayed) has no effect.

When the desired hookup type appears, press \square to save it. The hookup type stops blinking, indicating you have exited edit mode.

3.6.3 Selecting Nominal Current and Voltage

Configuration mode lets you set a voltage ratio for the transformer being measured (if necessary). This involves setting a primary nominal voltage and secondary nominal voltage for the transformer. To do this, display the Hookup configuration screen and proceed as follows:

1. Press \blacktriangledown to display the Primary Nominal Voltage (PT PRIM) configuration screen.

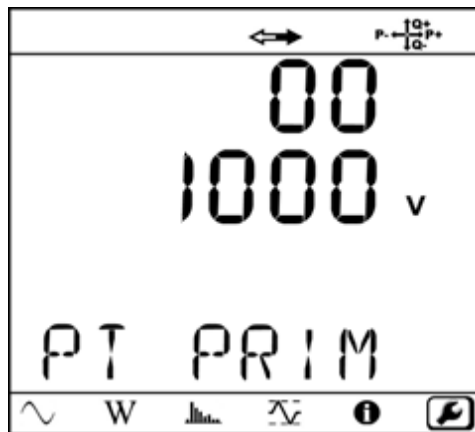

Figure 8

2. Press \square . The first digit of the primary nominal voltage value blinks. (Note that although this value is displayed on two separate lines, it is a single number.)
3. Press \blacktriangleleft or \blacktriangleright to navigate through the displayed digits.
4. When the desired digit is selected, press \blacktriangle or \blacktriangledown to change its value. The primary nominal voltage can range from 50 volts to 650000 volts.
5. Press \square when the displayed voltage is correct.
6. Press \blacktriangledown to display the Secondary Nominal Voltage (PT SEC) configuration screen. This functions similarly to the Primary Nominal Voltage screen. Allowable secondary nominal voltage values range from 50 to 1000V.



Figure 9

7. If a probe or sensor is connected, and the type of probe/sensor supports setting a transformer ratio, you can configure the primary nominal current appropriate for the probe. To do this, press ▼ at the Secondary Nominal Voltage configuration screen. This displays the Primary Nominal Current (CT PRIM) configuration screen.

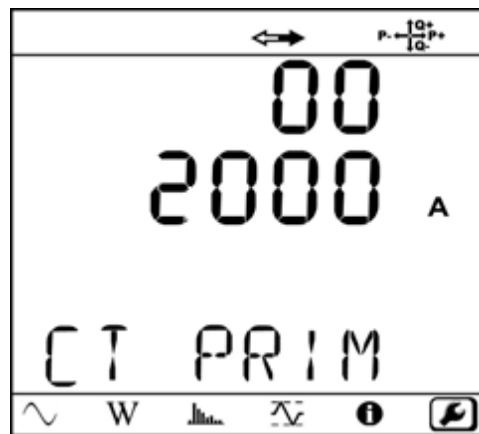

Figure 10

The primary nominal current depends on the type of probe/sensor or adapter:

- AmpFlex/MiniFlex: 100, 400, 2000, or 10000A
- MN93: automatic 200A
- MN193 5A range: 5 to 25000A
- MN193 100A range: automatic 100A
- S93: automatic 3500A
- SL261: 10 or 1000A
- SR193 and MR193: automatic 1000A
- 5A Adapter Box: 5 to 25000A
- BNC Adapter: 1 to 25000A

8. Press ⏪ and use the directional buttons to select the appropriate value.
9. Press ⏩ to save your changes.
10. If a probe or sensor is connected to the instrument's neutral input terminal, pressing ▼ at the Primary Nominal Current configuration screen displays the Primary Neutral Current screen. This screen functions similarly to the Primary Nominal Current screen. Allowable values are:
 - AmpFlex/MiniFlex: 100, 400, 2000, or 10000A
 - BNC Adapter: 1 to 25000A

3.6.4 Setting the Aggregation Period for a Recording

When recording data (see § 5), the instrument performs measurement aggregation. This involves determining the average value for a measured parameter over a user-specified time interval. This interval is called the aggregation period, and can be set in Configuration mode. To do this:

1. From the Hookup configuration screen, press \blacktriangle to display the Aggregation Period screen.

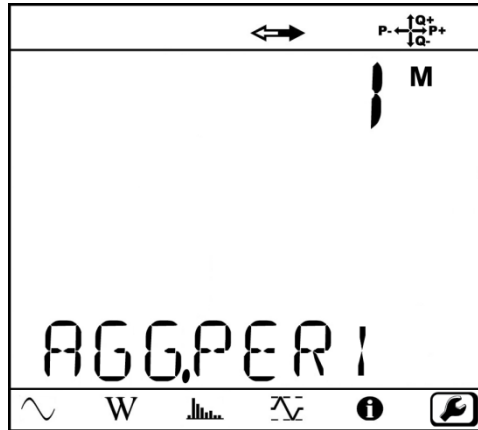



Figure 11

2. Press \square to select the aggregation period value.
3. Press \blacktriangle or \blacktriangledown to make changes. Available options in minutes are 1 through 6, 10, 12, 15, 20, 30, and 60.
4. Press \square to save your changes.

3.7 Viewing Instrument Information

Information mode enables you to review instrument information and settings. To enter Information mode:

1. Press \blacktriangleleft or \blacktriangleright until the Information  icon is selected.
2. Press \blacktriangle or \blacktriangledown to cycle through a series of read-only screens.

These screens display settings for the following:

- Hookup
- Primary nominal voltage
- Secondary nominal voltage
- Primary nominal current
- Primary nominal neutral current (when available)
- Aggregation period
- Date and time
- LAN IP address
- WiFi IP address
- Firmware revision number

4. OPERATION

4.1 Hooking Up to the Distribution System

The Model PEL 105 works with a variety of current probes and sensors. Choosing which type to use depends on the current to be measured and the diameter of the electrical cables. Each probe and sensor comes with its own documentation, which you should consult before connecting to the instrument.

The instrument may be supplied with four water-tight AmpFlex® Model A196-24-BK current probes. This 24" flexible probe measures the current in a cable without opening the circuit. The probe also comes in a 36" length (A193-36-BK). Their performance specifications are otherwise identical; although the A193-36-BK is not water-tight.

To connect the probe to the electrical network under measurement, do the following:

1. Connect the probe lead onto the appropriate current terminal. Which terminal to use depends on the hookup type, as explained later in this section. Note: When using AmpFlex A196-24-BK probe, be sure to screw the lead onto the threaded terminal to ensure water-tight (IP67) operation.
2. Open the probe by pressing the release levers on the side of the coupling and pulling out the end.
3. Wrap the probe around the electrical cable to be measured.
4. Close the probe by inserting the end back into the coupling.

This is the basic connection procedure for flexible loop probes. Clamp-on probes require a similar connection process.

The following table provides measurement specifications for supported probes and sensors. For detailed probe/sensor specifications, see § 7.9.

Model	Nominal Range	Measurement Range
Flexible Current Probe AmpFlex® Model A196-24-BK (waterproof – IP67)	100/400/2000/10000A _{AC}	200mA to 12000A _{AC}
Flexible Current Probe AmpFlex® Model 193-36-BK	100/400/2000/10000A _{AC}	200mA to 12000A _{AC}
Flexible Current Probe MiniFlex® MA193	100/400/2000/10000A _{AC}	200mA to 3000A _{AC}
AC/DC Current Probe J93	3500A _{AC} 5000A _{DC}	50 to 3500A _{AC} 50 to 5000A _{DC}
Clamp-On AC/DC Current Probe Model MR193-BK	1000A _{AC} , 1400A _{DC} max	1 to 1000A _{AC} , 1 to 1300A peak AC+DC
Clamp-On AC Current Probe Model MN93-BK	200A _{AC} for F ≤ 1kHz	0.5 to 240A _{AC} max (I > 200A not permanent)
Clamp-On AC Current Probe Model SR193-BK	1000A _{AC} for F ≤ 1 kHz	1 to 1200A _{AC} max (I > 1000A not continuously)
Clamp-On Current Probe Model MN193-36-BK	5A and 100A _{AC}	5A: 0.005 to 6A _{AC} max 100A: 0.2 to 120A _{AC} max
AC/DC Current Probe Model SL261 (requires a BNC Adapter, catalog #2140.40, for use with the PEL 105)	10A and 100A _{AC/DC}	100mV/A: 50mA to 10A peak 10mV/A: 0.5 to 100A peak

The PEL 105 supports 17 hookup types. For each, the following sections provide:

- A connection diagram. This includes a depiction of the instrument's current terminals I1, I2, I3, and IN (neutral); and voltage terminals V1, V2, V3, VN, and VE/GND (ground/earth). The diagram also includes an illustration of how the current probes and voltage leads are connected to electrical lines, neutral, and ground.
- An icon showing the direction towards the load.
- Instructions for how to connect the probes and leads.

In each diagram, the top row of terminals connect current probes/sensors, the bottom row connect voltage test leads. The labels identify the input terminals functions. For example, I1 connects a current probe/sensor to line 1; I2 connects to line 2, and so on.

The following instructions assume you will use the neutral current terminal and the ground/earth voltage terminal. Use of these terminals is not strictly required; however they provide a higher level of accuracy when used.

For all hookups, ensure that the arrow on the probe is directed towards the load (for example, see Figure 12). This provides proper phase angle for power measurements and other phase-sensitive measurements.



Figure 12

NOTE: When connecting to the electrical network, be sure to observe all safety precautions as stated in the documentation that accompanies the probes and sensors.

4.1.1 Single-Phase 2-Wire (1P-2W)

Connect:

- VN test lead to neutral (N).
- VE/GND test lead to ground (optional, normally not used in this hookup).
- V1 test lead to L1.
- IN probe to neutral (optional, normally not used in this hookup).
- I1 probe to L1.

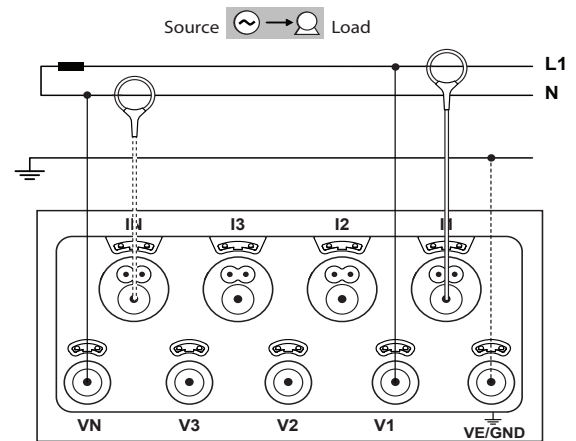

Figure 13

4.1.2 Single-Phase 3-Wire (1P-3W)

Split phase from a center tap transformer.

Connect:

- VN test lead to neutral (N).
- VE/GND test lead to ground (optional, normally not used in this hookup).
- V1 test lead to L1.
- V2 test lead to L2.
- IN probe to neutral (optional, normally not used in this hookup).
- I1 probe to L1.
- I2 probe to L2.

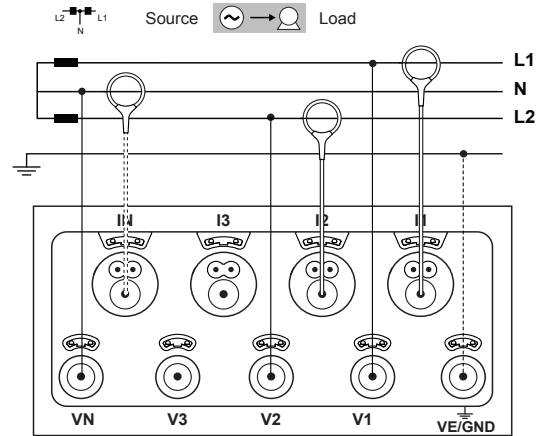

Figure 14

4.1.3 3-Phase 3-Wire Δ (2 current probes) (3P-3W Δ 2)

Connect:

- VE/GND test lead to ground.
- V1 test lead to L1.
- V2 test lead to L2.
- V3 test lead to L3.
- I1 probe to L1.
- I3 probe to L3.

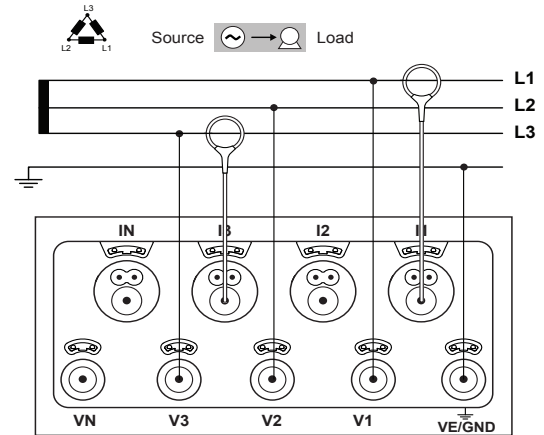

Figure 15

4.1.4 3-Phase 3-Wire Δ (3 current probes) (3P-3W Δ 3)

Connect:

- VE/GND test lead to ground.
- V1 test lead to L1.
- V2 test lead to L2.
- V3 test lead to L3.
- I1 probe to L1.
- I2 probe to L2.
- I3 probe to L3.

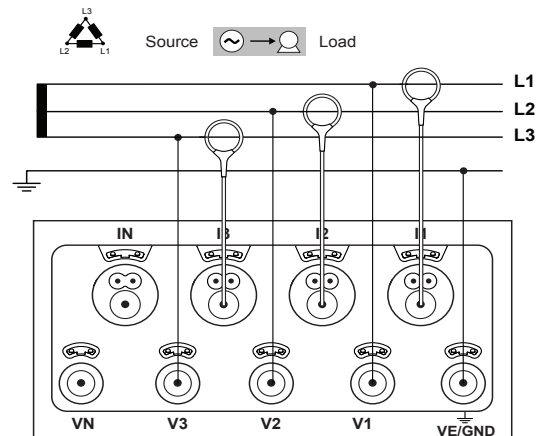

Figure 16

4.1.5 3-Phase 3-Wire Open Δ (2 current probes) (3P-3W02)

Connect:

- VE/GND test lead to ground.
- V1 test lead to L1.
- V2 test lead to L2.
- V3 test lead to L3.
- I1 probe to L1.
- I3 probe to L3.

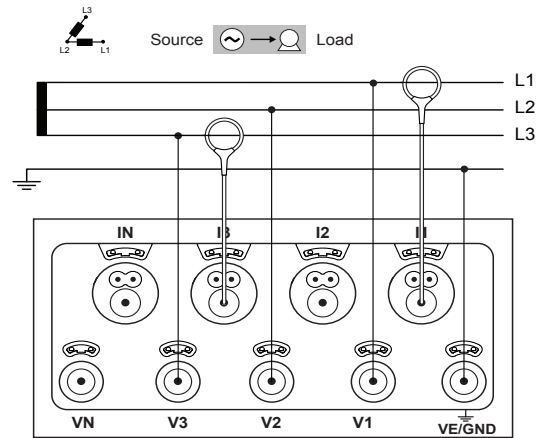

Figure 17

4.1.6 3-Phase 3-Wire Open Δ (3 current probes) (3P-3W03)

Connect:

- VE/GND test lead to ground.
- V1 test lead to L1.
- V2 test lead to L2.
- V3 test lead to L3.
- I1 probe to L1.
- I2 probe to L2.
- I3 probe to L3.

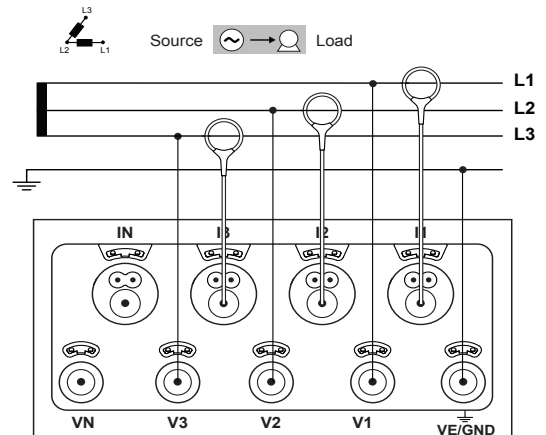

Figure 18

4.1.7 3-Phase 3-Wire Y (2 current probes) (3P-3WY2)

Connect:

- VE/GND test lead to ground.
- V1 test lead to L1.
- V2 test lead to L2.
- V3 test lead to L3.
- I1 probe to L1.
- I3 probe to L3.

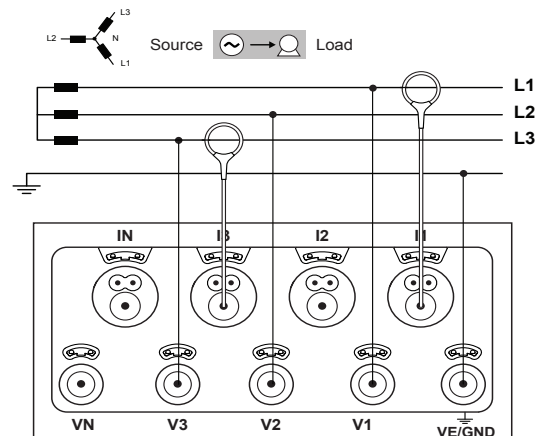

Figure 19

4.1.8 3-Phase 3-Wire Y (3 current probes) (3P-3WY3)

Connect:

- VE/GND test lead to ground.
- V1 test lead to L1.
- V2 test lead to L2.
- V3 test lead to L3.
- I1 probe to L1.
- I2 probe to L2.
- I3 probe to L3.

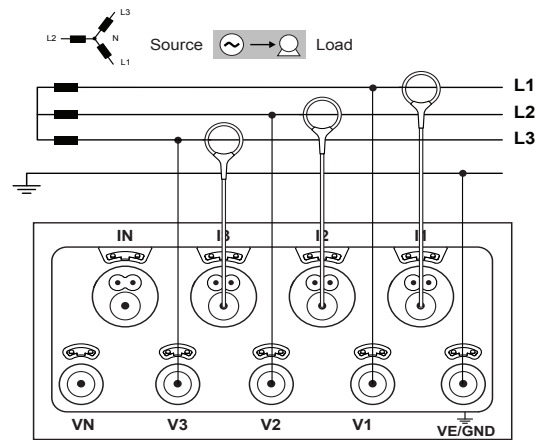

Figure 20

4.1.9 3-Phase 3-Wire Δ Balanced (1 current probe) (3P3W Δ b)

Connect:

- VE/GND test lead to ground.
- V1 test lead to L1.
- V2 test lead to L2.
- I3 probe to L3.

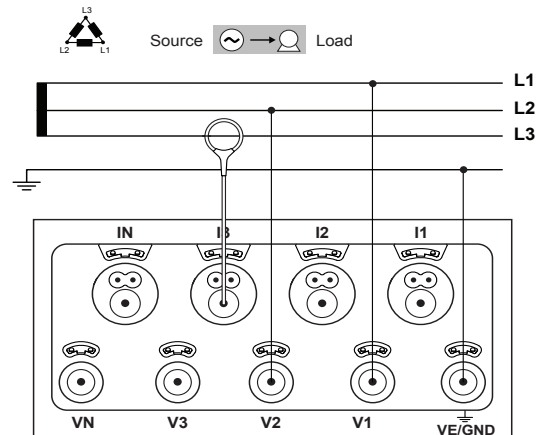

Figure 21

4.1.10 3-Phase 4-Wire Y (3P-4WY)

Connect:

- VE/GND test lead to ground.
- VN test lead to neutral (N).
- V1 test lead to L1.
- V2 test lead to L2.
- V3 test lead to L3.
- IN probe to neutral.
- I1 probe to L1.
- I2 probe to L2.
- I3 probe to L3.

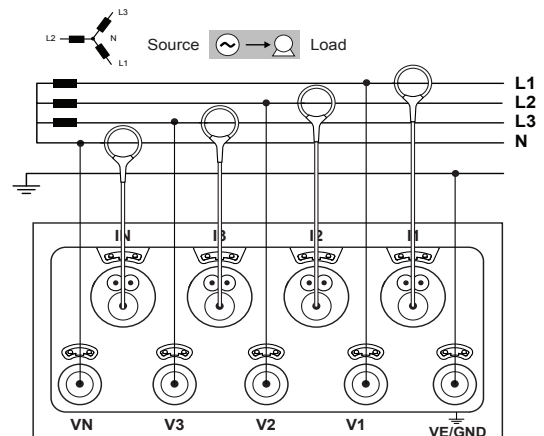

Figure 22

4.1.11 3-Phase 4-Wire Y Balanced (3P-4WYb)

Connect:

- VE/GND test lead to ground.
- VN test lead to neutral (N).
- V1 test lead to L1.
- IN probe to neutral.
- I1 probe to L1.

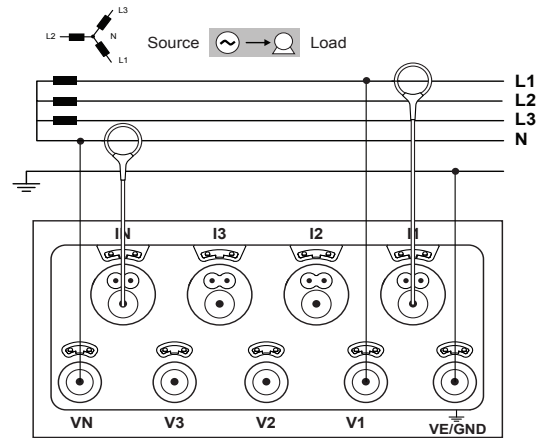

Figure 23

4.1.12 3-Phase 4-Wire Y 2½ Element (3P-4WY2)

Connect:

- VE/GND test lead to ground.
- VN test lead to neutral (N).
- V1 test lead to L1.
- V3 test lead to L3.
- IN probe to neutral.
- I1 probe to L1.
- I2 probe to L2.
- I3 probe to L3.

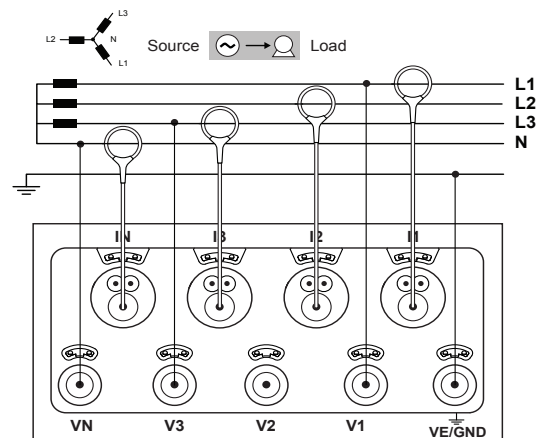

Figure 24

4.1.13 3-Phase 4-Wire Δ (3P-4WΔ)

Connect:

- VE/GND test lead to ground.
- VN test lead to neutral (N).
- V1 test lead to L1.
- V2 test lead to L2.
- V3 test lead to L3.
- IN probe to neutral.
- I1 probe to L1.
- I2 probe to L2.
- I3 probe to L3.

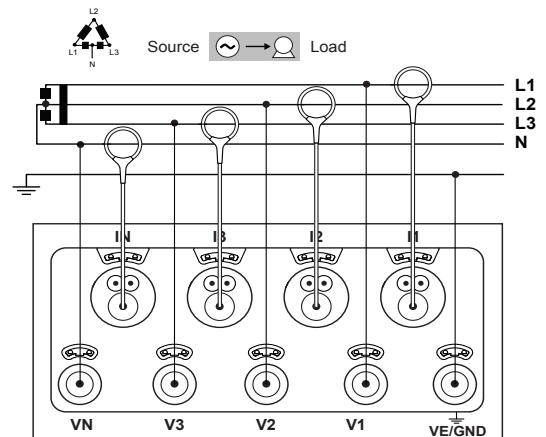

Figure 25

4.1.14 3-Phase 4-Wire Open Δ (3P-4WO)

Connect:

- VE/GND test lead to ground.
- VN test lead to neutral (N).
- V1 test lead to L1.
- V2 test lead to L2.
- V3 test lead to L3.
- IN probe to neutral.
- I1 probe to L1.
- I2 probe to L2.
- I3 probe to L3.

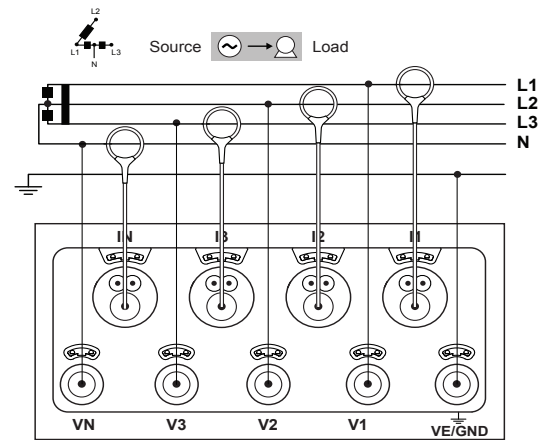

Figure 26

4.1.15 DC 2-Wire (dC-2W)

Connect:

- VE/GND test lead to ground.
- VN test lead to the common conductor.
- V1 test lead to conductor +1.
- IN probe to the common conductor.
- I1 probe to conductor +1.

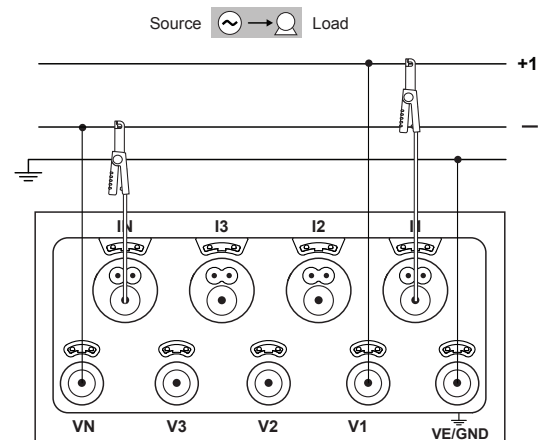

Figure 27

4.1.16 DC 3-Wire (dC-3W)

Connect:

- VE/GND test lead to ground.
- VN test lead to the common conductor.
- V1 test lead to conductor +1.
- V2 test lead to conductor +2.
- IN probe to the common conductor.
- I1 probe to conductor +1.
- I2 probe to conductor +2.

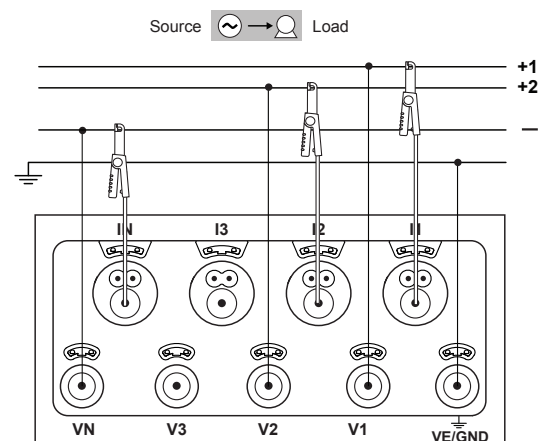

Figure 28

4.1.17 DC 4-Wire (dC-4W)

Connect:

- VE/GND test lead to ground.
- VN test lead to the common conductor.
- V1 test lead to conductor +1.
- V2 test lead to conductor +2.
- V3 test lead to conductor +3.
- IN probe to the common conductor.
- I1 probe to conductor +1.
- I2 probe to conductor +2.
- I3 probe to conductor +3.

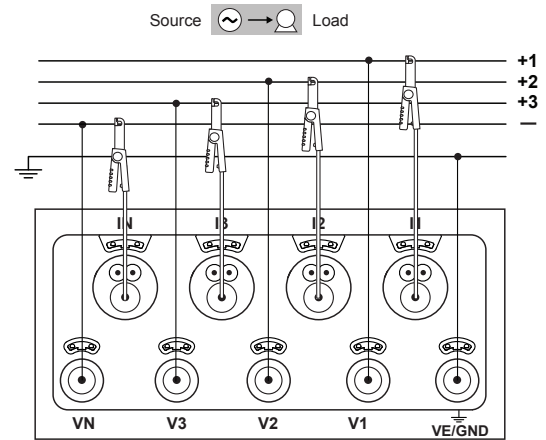





Figure 29

4.2 Viewing Data

The PEL 105 provides four data viewing modes:

-  **Measurement** mode displays real-time data currently being measured by the probes/sensors. This includes voltage, current, power, frequency, power factor, and tangent angle.
-  **Energy** mode displays energy use, including reactive energy, apparent energy, and kilowatt hour.
-  **Harmonics** mode displays harmonics for currents and voltages.
-  **Maximum** mode displays the maximum values for measurement and energy values.

Press ◀ or ▶ to navigate to the desired mode. When a mode is selected, a box appears around its icon at the bottom of the display screen (Figure 5). Each mode provides a set of screens for viewing data. Press ▲ or ▼ to navigate through these screens. Some of these screens include additional information which you can view by pressing ⏏. For example, several Measurement mode screens display phase angle information when you press ⏏. Pressing ▲ or ▼ while viewing an additional information screen returns to the previous screen.

The sequence of screens, and the information each one shows, is dependent on the electrical hookup setting.

The following tables list the screens available in Measurement, Energy, Harmonics, and Maximum modes. For each screen, the following information is displayed:

- Image of the screen.
- Title of screen, summarizing the information it displays.
- Button to push to view the screen, shown to the left of the screen shot.
- A list of the variables displayed on the screen, shown to the right of the screen image. These variables are defined in the Glossary.

4.2.1 Measurement Mode

4.2.1.1 1-Phase 2-Wire (1P-2W)

The diagram illustrates the navigation sequence for 1-Phase 2-Wire measurements. It consists of four screens, each with a set of icons on the left and right sides. The screens are connected by arrows indicating the navigation path.

Screen 1: Active power/current/voltage (1-phase 2-wire)
 Displays: 654.9 W, 3.000 A, 21.88 V, VNE 7.30 V.
 Labels: P, I, V, V_N.
 Navigation: Right arrow (up), Down arrow (right), Up arrow (down).





Screen 2: Phase angle (1-phase 2-wire)
 Displays: 8 (φ(I₁, V₁)), IV ANGL.
 Labels: L1, L2, L3.
 Navigation: Down arrow (left), Up arrow (left).

Screen 3: Frequency (1-phase 2-wire)
 Displays: 654.9 W, 3.000 A, 21.88 V, 60.00 Hz.
 Labels: P, I, V, F.
 Navigation: Down arrow (left).





Screen 4: Power (1-phase 2-wire)
 Displays: 654.9 W, 658.4 VAR, 958.7 VA, PF 0.68.
 Labels: P, Q, S, PF.
 Navigation: Down arrow (left).

Screen 5: Tangent (1-phase 2-wire)
 Displays: 654.9 W, 658.4 VAR, 958.7 VA, TAN 0.14.
 Labels: P, Q, S, TAN.
 Navigation: Down arrow (left).

To view 1-phase 2-wire measurement data, do the following:

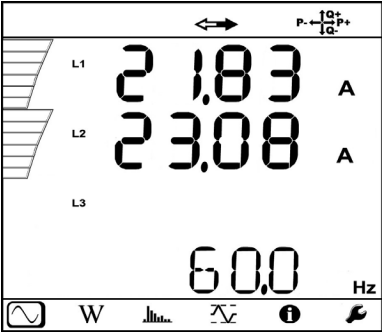

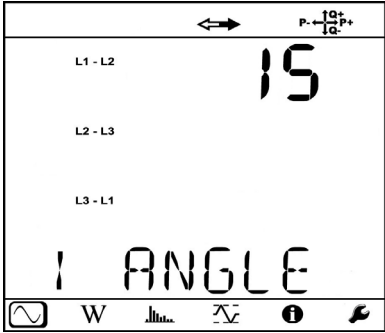
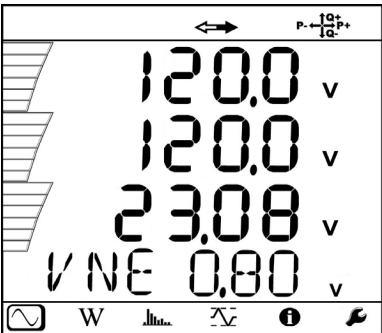
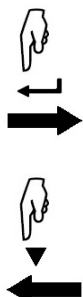
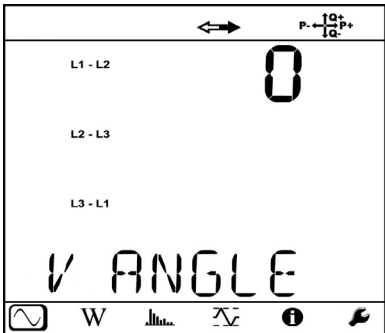
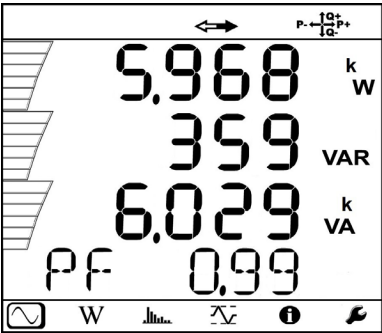

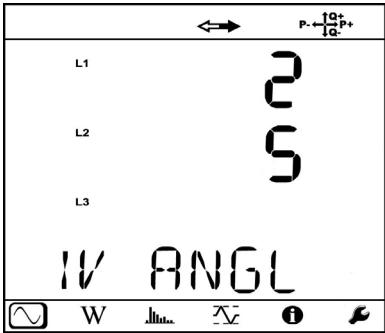
1. Turn ON the instrument, and enter Configuration mode by pressing either ◀ or ▶ until the Configuration  icon is highlighted (see § 3.6.1). The Hookup screen will be displayed.
2. Press  to enter edit mode, then press ▲ or ▼ to navigate to the hookup type 1P-2W. Press  to save the configuration.
3. Hook up the probes and sensors to the 1-phase 2-wire distribution system, as instructed by § 4.1.1.
4. Press ◀ or ▶ until the  icon is selected. This displays the first measurement screen for a 1-phase 2-wire hookup (Active power/current/voltage).
5. Navigate through the measurement screens as instructed in the previous table.

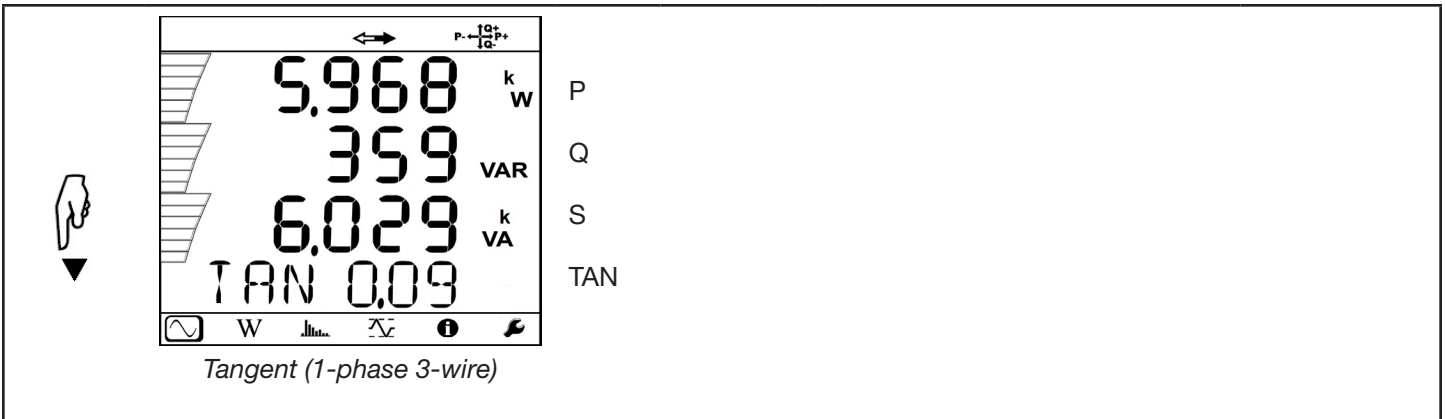
4.2.1.2 1-Phase 3-Wire (1P-3W)

 <p>Line current/frequency (1-phase 3-wire)</p>	I_1 I_2 F		 <p>Current phase angle (1-phase 3-wire)</p>	$\varphi (I_2, I_1)$
 <p>Voltage (1-phase 3-wire)</p>	V_1 V_2 U_{12} V_N		 <p>Voltage phase angle (1-phase 3-wire)</p>	$\varphi (V_2, V_1)$
 <p>Power (1-phase 3-wire)</p>	P Q S PF		 <p>Phase angles between line currents/voltages (1-phase 3-wire)</p>	$\varphi (I_1, V_1)$ $\varphi (I_2, V_2)$



To view 1-phase 3-wire measurement data, do the following:

1. Turn ON the instrument, and enter Configuration mode by pressing either ◀ or ▶ until the Configuration  icon is highlighted (see § 3.6.1). The Hookup screen will be displayed.
2. Press  to enter edit mode, then press ▲ or ▼ to navigate to the hookup type 1P-3W. Press  to save the configuration.
3. Hook up the probes and sensors to the 1-phase 3-wire distribution system, as instructed by § 4.1.2.
4. Press ◀ or ▶ until the  icon is selected. This displays the first measurement screen for a 1-phase 3-wire hookup (Line current/frequency).
5. Navigate through the measurement screens as instructed in the table above.

4.2.1.3 3-Phase 3-Wire Unbalanced

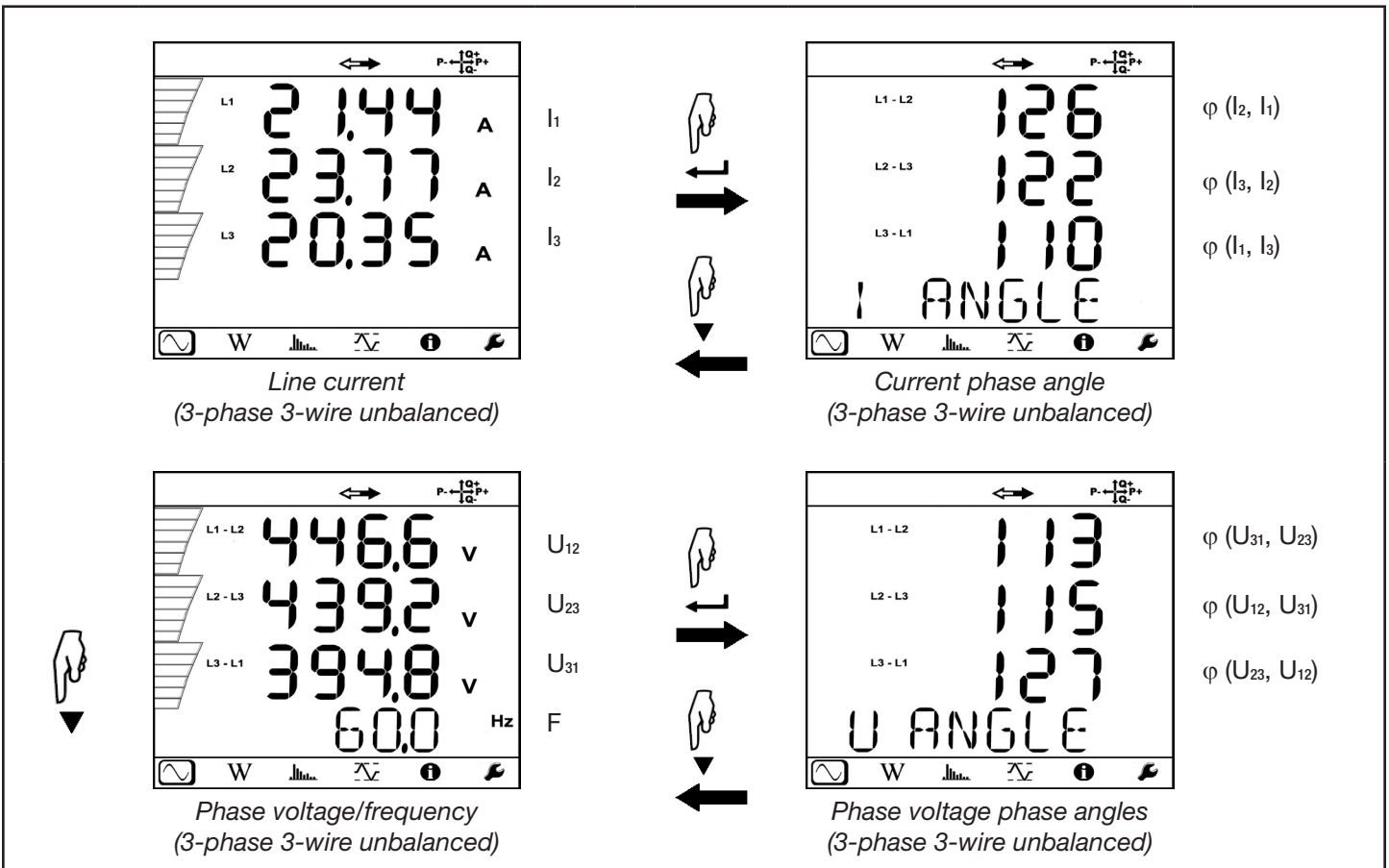

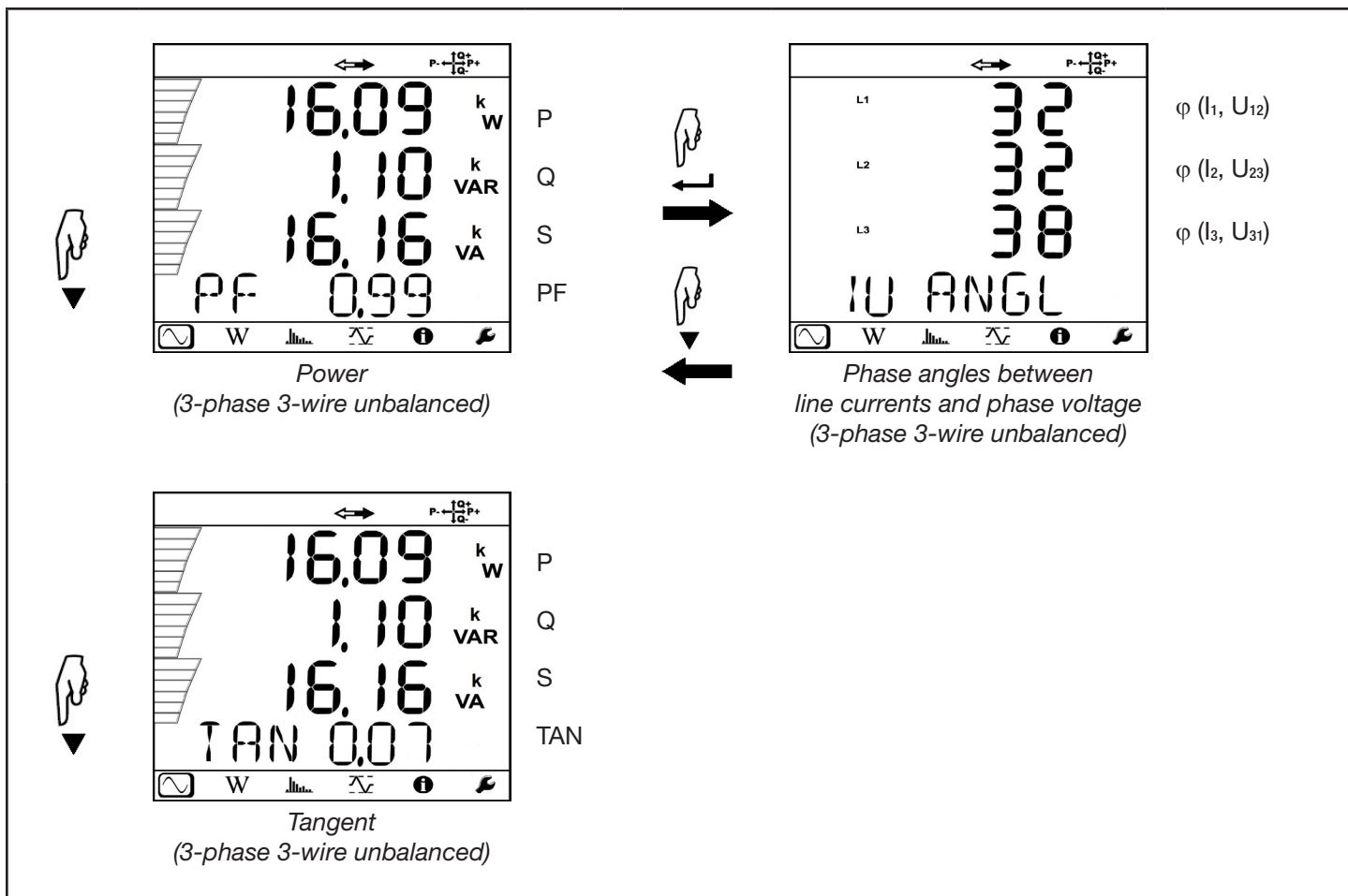



Measurement mode consists of seven screens when the hookup setting is one of the following:

- 3P-3W Δ 2 (3-phase 3-wire Δ , two probes)
- 3P-3W Δ 3 (3-phase 3-wire Δ , three probes)
- 3P-3WO2 (3-phase 3-wire open Δ , two probes)
- 3P-3WO3 (3-phase 3-wire open Δ , three probes)
- 3P-3WY2 (3-phase 3-wire Y, two probes)
- 3P-3WY3 (3-phase 3-wire Y, three probes)

To view 3-phase 3-wire unbalanced measurement data, do the following:

1. Turn ON the instrument, and enter Configuration mode by pressing either \blacktriangleleft or \blacktriangleright until the Configuration  icon is highlighted (see § 3.6.1). The Hookup screen will be displayed.
2. Press \square to enter edit mode, then press \blacktriangle or \blacktriangledown to navigate to the appropriate 3-phase 3-wire unbalanced hookup type (see the list above). Press \square to save the configuration.
3. Hook up the probes and sensors to the 3-phase 3-wire unbalanced distribution system, as instructed by §§ 4.1.3 through 4.1.8 (each of these sections describes a different 3-phase 3-wire unbalanced hookup type).
4. Press \blacktriangleleft or \blacktriangleright until the  icon is selected. This displays the first measurement screen for a 3-phase 3-wire unbalanced hookup (Line current).
5. Navigate through the measurement screens as instructed in the table above.

4.2.1.4 3-Phase 3-Wire Δ Balanced (3P-3W Δ b)

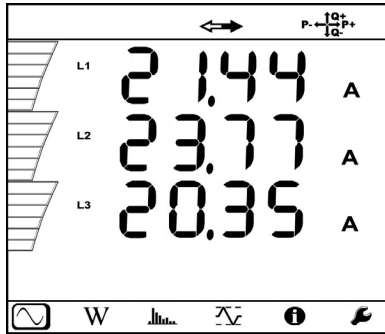

Phase voltage/frequency
(3-phase 3-wire Δ balanced)

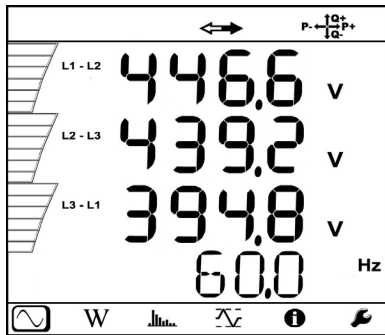

Phase voltage/frequency
(3-phase 3-wire Δ balanced)

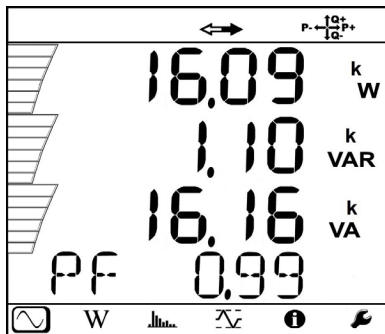

Power
(3-phase 3-wire Δ balanced)

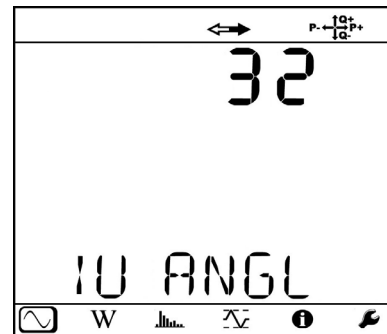

Phase angle between
line current and phase voltage
(3-phase 3-wire Δ balanced)

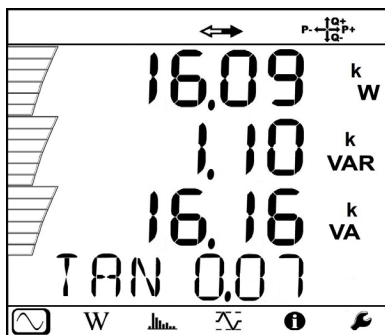

Tangent
(3-phase 3-wire Δ balanced)

To view 3-phase 3-wire Δ balanced measurement data, do the following:

1. Turn ON the instrument, and enter the Configuration mode by pressing either \blacktriangleleft or \blacktriangleright until the Configuration icon is highlighted (see § 3.6.1). The Hookup screen will be displayed.
2. Press \square to enter edit mode, then press \blacktriangle or \blacktriangledown to navigate to 3P-3W Δ b. Press \square to save the configuration.
3. Hook up the probes and sensors to the 3-phase 3-wire balanced distribution system, as instructed by § 4.1.9.
4. Press \blacktriangleleft or \blacktriangleright until the \square icon is selected. This displays the first measurement screen for a 3-phase 3-wire balanced hookup (Phase voltage/frequency).
5. Navigate through the measurement screens as instructed in the previous table.

4.2.1.5 3-Phase 4-Wire Unbalanced



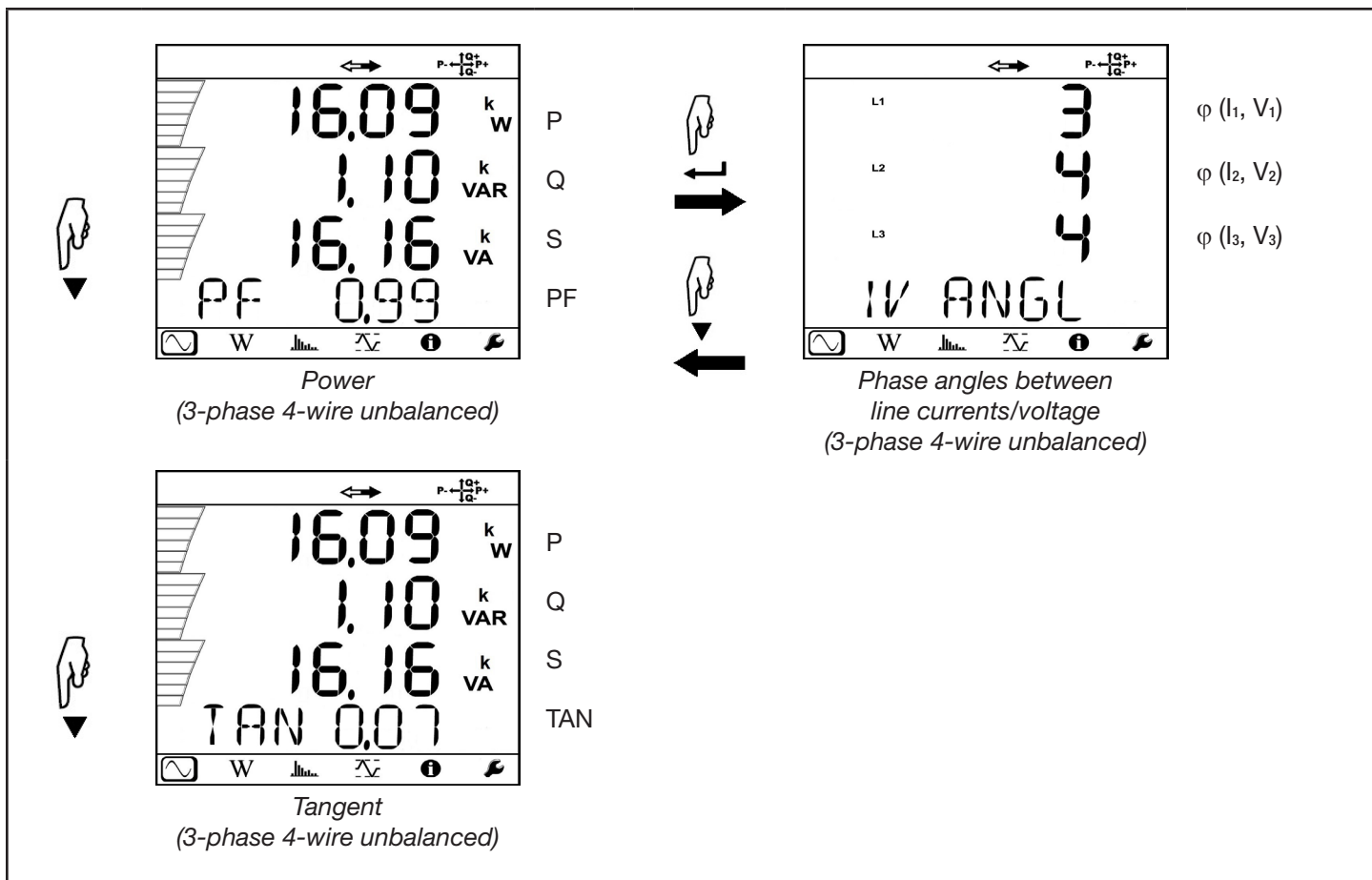

	I_1 I_2 I_3 I_N			$\varphi(I_2, I_1)$ $\varphi(I_3, I_2)$ $\varphi(I_1, I_3)$
	V_1 V_2 V_3 V_N			$\varphi(V_2, V_1)$ $\varphi(V_3, V_2)$ $\varphi(V_1, V_3)$
	U_{12} U_{23} U_{31} F			$\varphi(U_{31}, U_{23})$ $\varphi(U_{12}, U_{31})$ $\varphi(U_{23}, U_{12})$



Measurement mode consists of nine screens when the hookup setting is one of the following:

- 3P-4WY (3-phase 4-wire Y)
- 3P-4WY2 (3-phase 4-wire Y, two probes)
- 3P-4W Δ (3-phase 4-wire Δ)
- 3P-4WO (3-phase 4-wire open Δ)

To view 3-phase 4-wire unbalanced measurement data, do the following:

1. Turn ON the instrument, and enter Configuration mode by pressing either \blacktriangleleft or \blacktriangleright until the Configuration  icon is highlighted (see § 3.6.1. The Hookup screen will be displayed).
2. Press  to enter edit mode, then press \blacktriangle or \blacktriangledown to navigate to the appropriate 3-phase 4-wire unbalanced hookup type (see the list above). Press  to save the configuration.
3. Hook up the probes and sensors to the 3-phase 4-wire unbalanced distribution system, as instructed by § 4.1.10, 4.1.12, 4.1.13, and 4.1.14 (each of these sections describes a different 3-phase 4-wire unbalanced hookup type).
4. Press \blacktriangleleft or \blacktriangleright until the  icon is selected. This displays the first measurement screen for a 3-phase 4-wire unbalanced hookup (Line current).
5. Navigate through the measurement screens as instructed in the table above.

4.2.1.6 3-Phase 4-Wire Y Balanced (3P-4WYb)

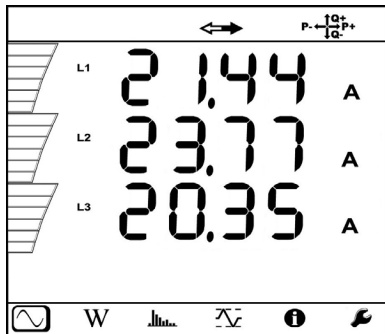

Line current
(3-phase 4-wire Y balanced)

I_1
 I_2
 I_3

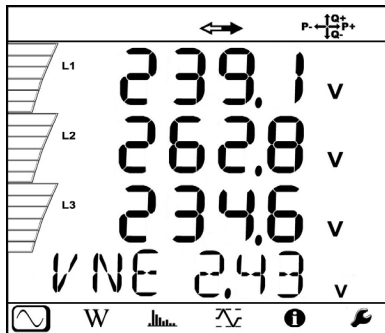

Line voltage
(3-phase 4-wire Y balanced)

V_1
 V_2
 V_3
 V_N

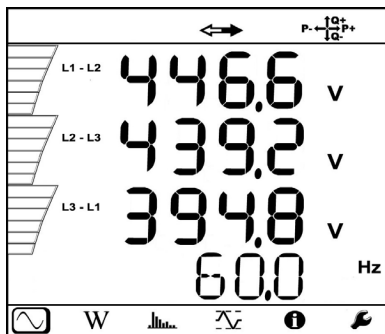

Phase voltage/frequency
(3-phase 4-wire Y balanced)

U_{12}
 U_{23}
 U_{31}
F

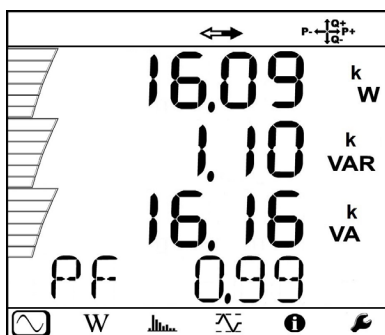

Power
(3-phase 4-wire Y balanced)

P
Q
S
PF

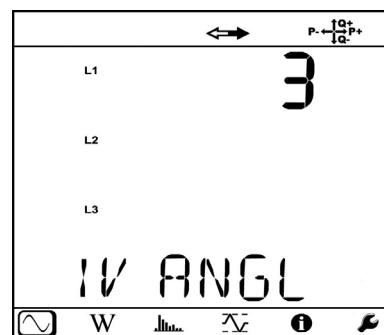



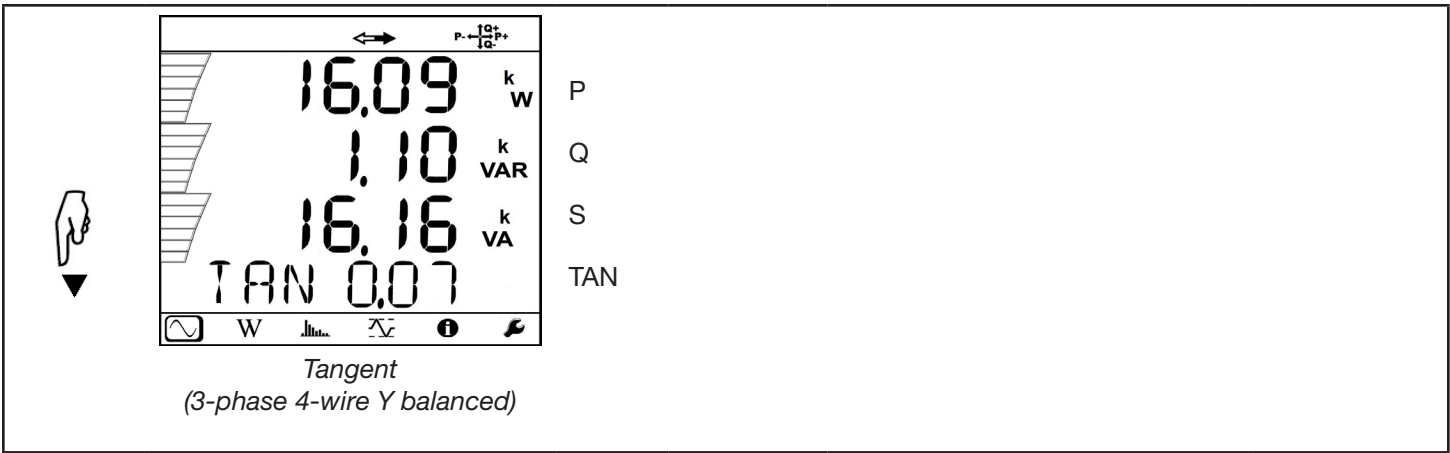

Phase angles between
line current/voltage
(3-phase 4-wire Y balanced)

$\phi (I_1, V_1)$





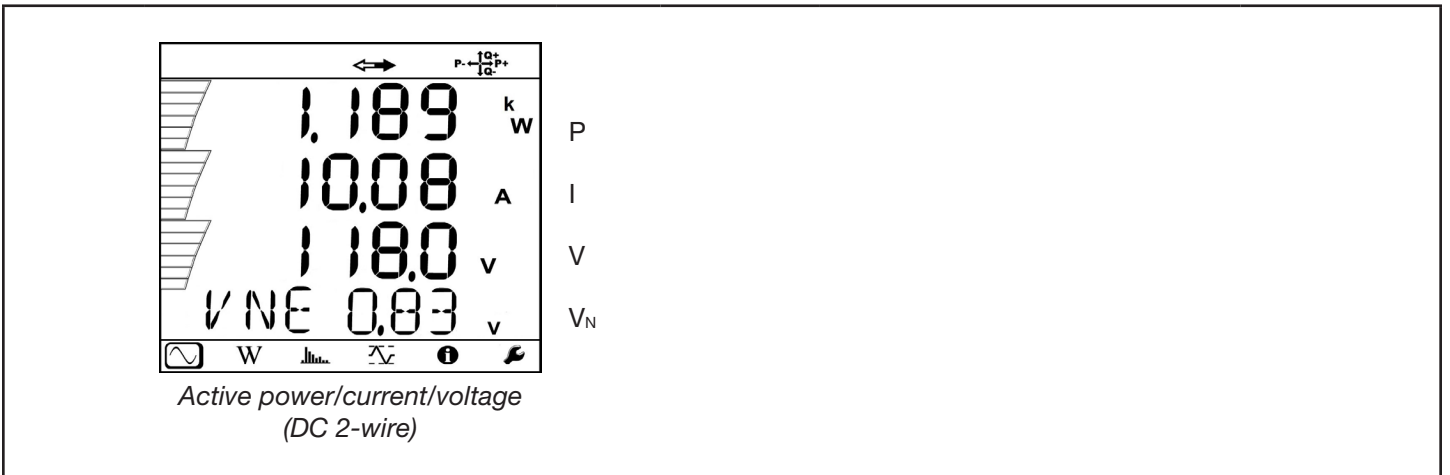

To view 3-phase 4-wire Y balanced measurement data, do the following:

1. Turn ON the instrument, and enter Configuration mode by pressing either ◀ or ▶ until the Configuration  icon is highlighted (see § 3.6.1). The Hookup screen will be displayed.
2. Press  to enter edit mode, then press ▲ or ▼ to navigate to 3P-4WYb. Press  to save the configuration.
3. Hook up the probes and sensors to the 3-phase 4-wire Y balanced distribution system, as instructed by § 4.1.11.
4. Press ◀ or ▶ until the  icon is selected. This displays the first measurement screen for a 3-phase 4-wire Y balanced hookup (Line current).
5. Navigate through the measurement screens as instructed in the table above.

4.2.1.7 DC 2-Wire (dC-2W)





To view DC 2-wire measurement data, do the following:

1. Turn ON the instrument, and enter Configuration mode by pressing either ◀ or ▶ until the Configuration  icon is highlighted (see § 3.6.1). The Hookup screen will be displayed.
2. Press  to enter edit mode, then press ▲ or ▼ to navigate to dC-2W. Press  to save the configuration.
3. Hook up the probes and sensors to the DC 2-wire distribution system, as instructed by § 4.1.15.
4. Press ◀ or ▶ until the  icon is selected. This displays the measurement screen for a DC 2-wire hookup (Active power/current/voltage).

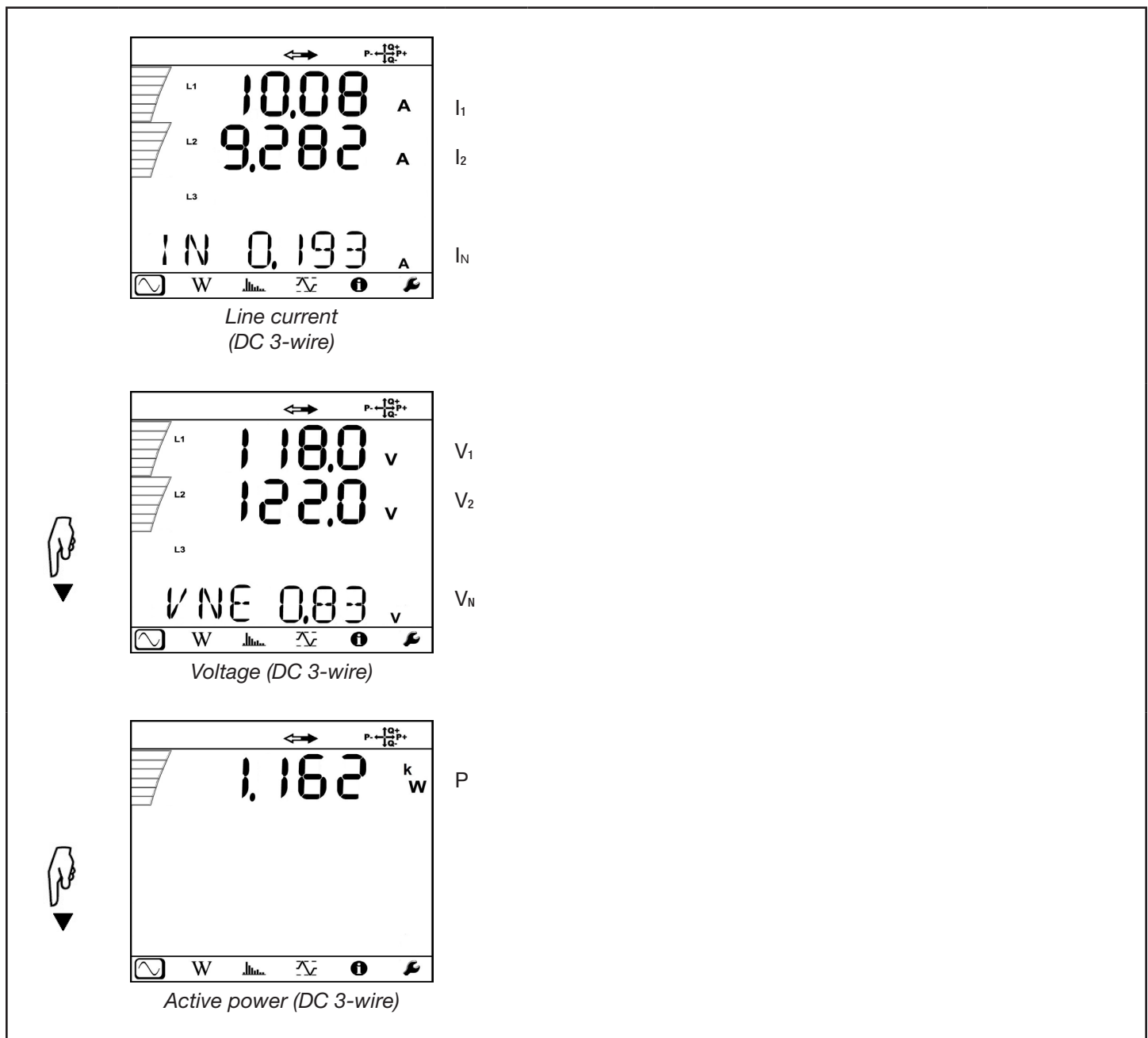
4.2.1.8 DC 3-Wire (dC-3W)





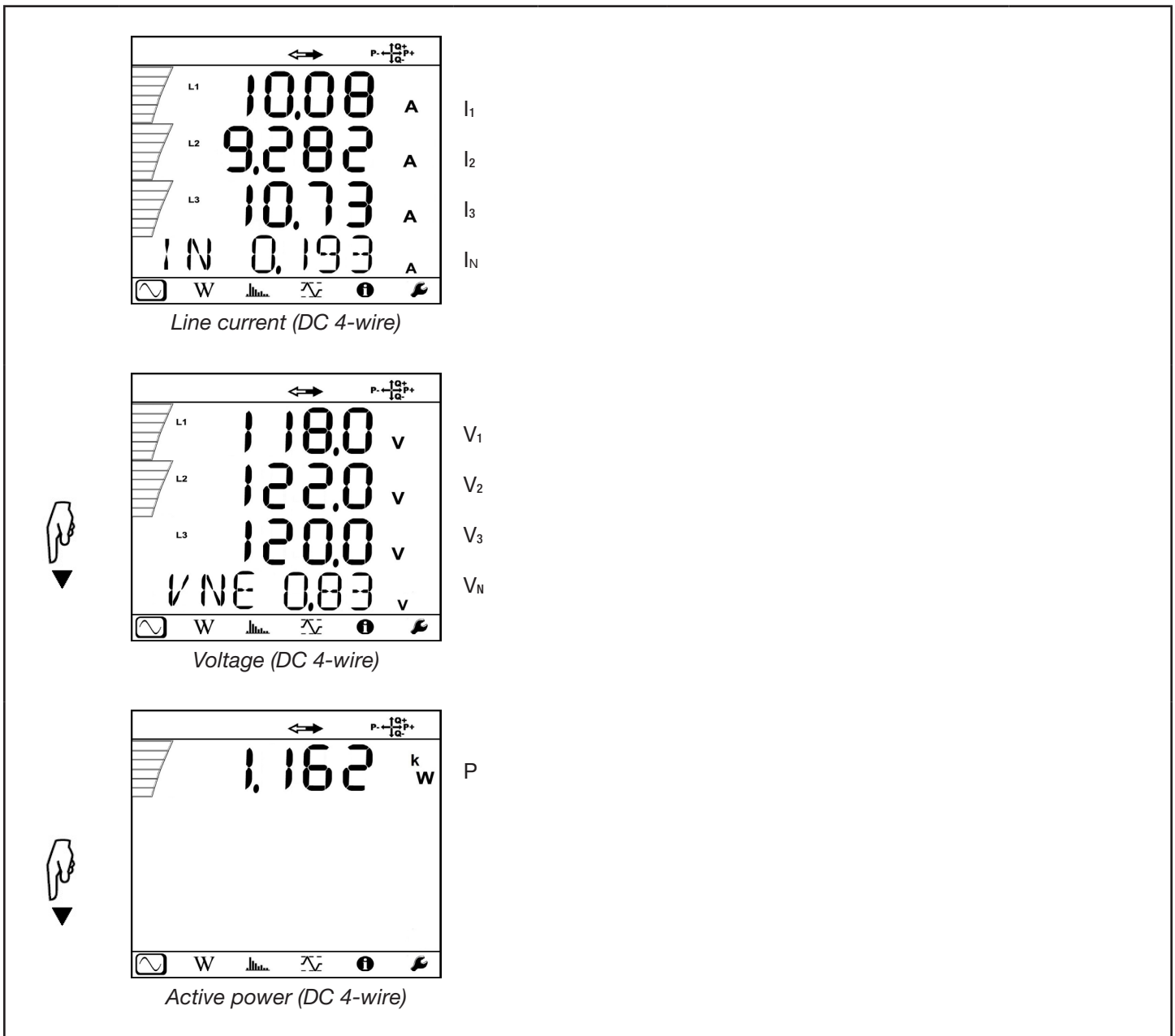

To view DC 3-wire measurement data, do the following:

1. Turn ON the instrument, and enter the Configuration mode by pressing either ◀ or ▶ until the Configuration icon is highlighted (see § 3.6.1). The Hookup screen will be displayed.
2. Press  to enter edit mode, then press ▲ or ▼ to navigate to dC-3W. Press  to save the configuration.
3. Hook up the probes and sensors to the DC 3-wire distribution system, as instructed by § 4.1.16.
4. Press ◀ or ▶ until the  icon is selected. This displays the first measurement screen for a DC 3-wire hookup (Line current).
5. Navigate through the measurement screens as instructed in the table above.

4.2.1.9 DC 4-Wire (dC-4W)



To view DC 4-wire measurement data, do the following:

1. Turn ON the instrument, and enter the Configuration mode by pressing either ◀ or ▶ until the Configuration  icon is highlighted (see § 3.6.1). The Hookup screen will be displayed.
2. Press  to enter edit mode, then press ▲ or ▼ to navigate to dC-4W. Press  to save the configuration.
3. Hook up the probes and sensors to the DC 4-wire distribution system, as instructed by § 4.1.17.
4. Press ◀ or ▶ until the  icon is selected. This displays the first measurement screen for a DC 4-wire hookup (Line current).
5. Navigate through the measurement screens as instructed in the table above.

4.2.2 Energy Mode

Select the  icon to enter the Energy mode. These screens display energy magnitudes for power flow quadrants, which per IEC 62053-23 are defined as Quadrant 1 (Inductive Import), Quadrant 2 (Capacitive Export), Quadrant 3 (Inductive Export), and Quadrant 4 (Capacitive Import).

When you display a screen, it shows full values for the displayed parameters. Energy measurements are time-dependent, typically with 10 or 15 minute integration or aggregation periods.

When viewing an Energy mode screen:

Press  to display partial values for energy parameters. (The word “PArT” appears on the screen when you view partial values.)

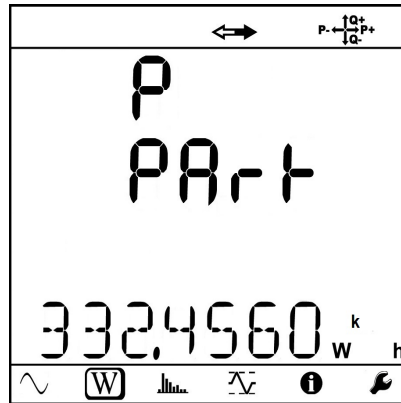

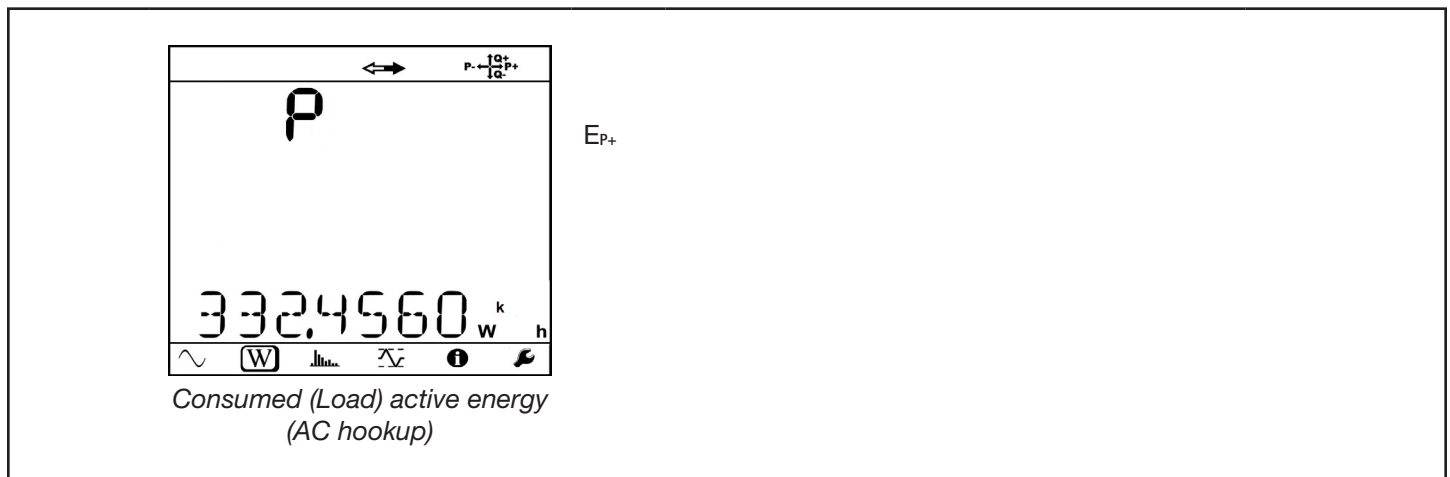

Figure 30

Press  to restore the display of full values.

There are two sets of Energy mode screens, one for AC hookups and one for DC.

4.2.2.1 AC Energy Screens



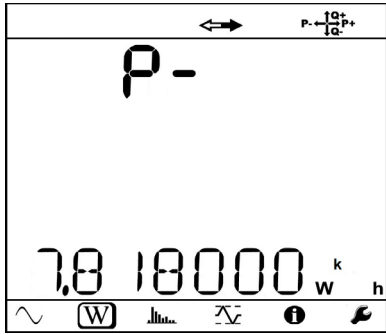

E_p

Generated (Source) active energy
(AC hookup)

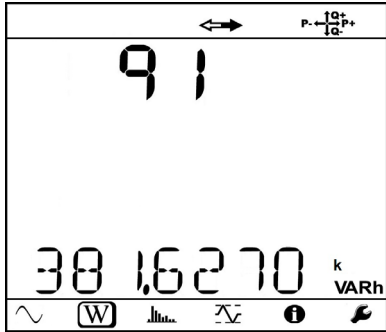

E_{Q1}

Reactive energy on Quadrant 1
(Inductive Import)

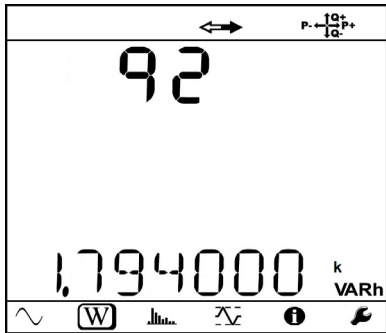

E_{Q2}

Reactive energy on Quadrant 2
(Capacitive Export)

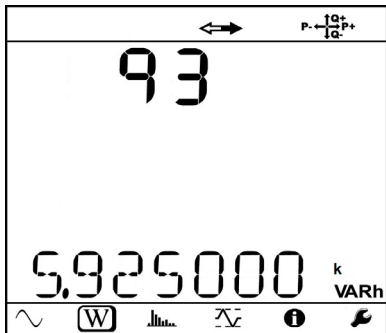

E_{Q3}

Reactive energy on Quadrant 3
(Inductive Export)

Note that for this and the following quadrant screens, the character **Q** represents the letter Q.

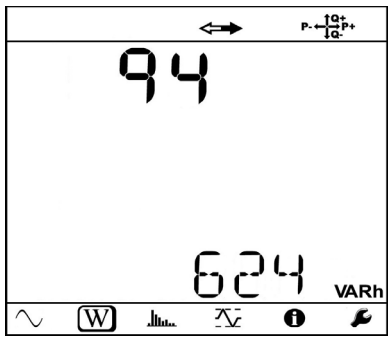

E04

Reactive energy on Quadrant 4
(Capacitive Import)

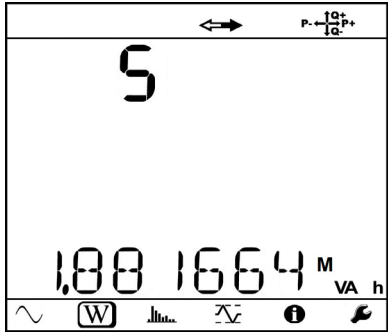

ES+

Consumed (Load) apparent
energy

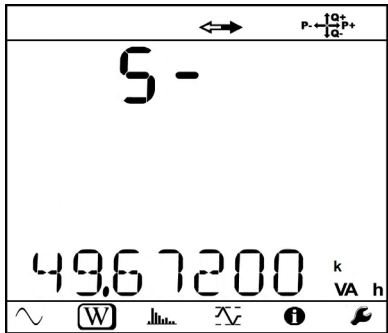

ES-

Generated (Source) apparent
energy



4.2.2.2 DC Energy Screens

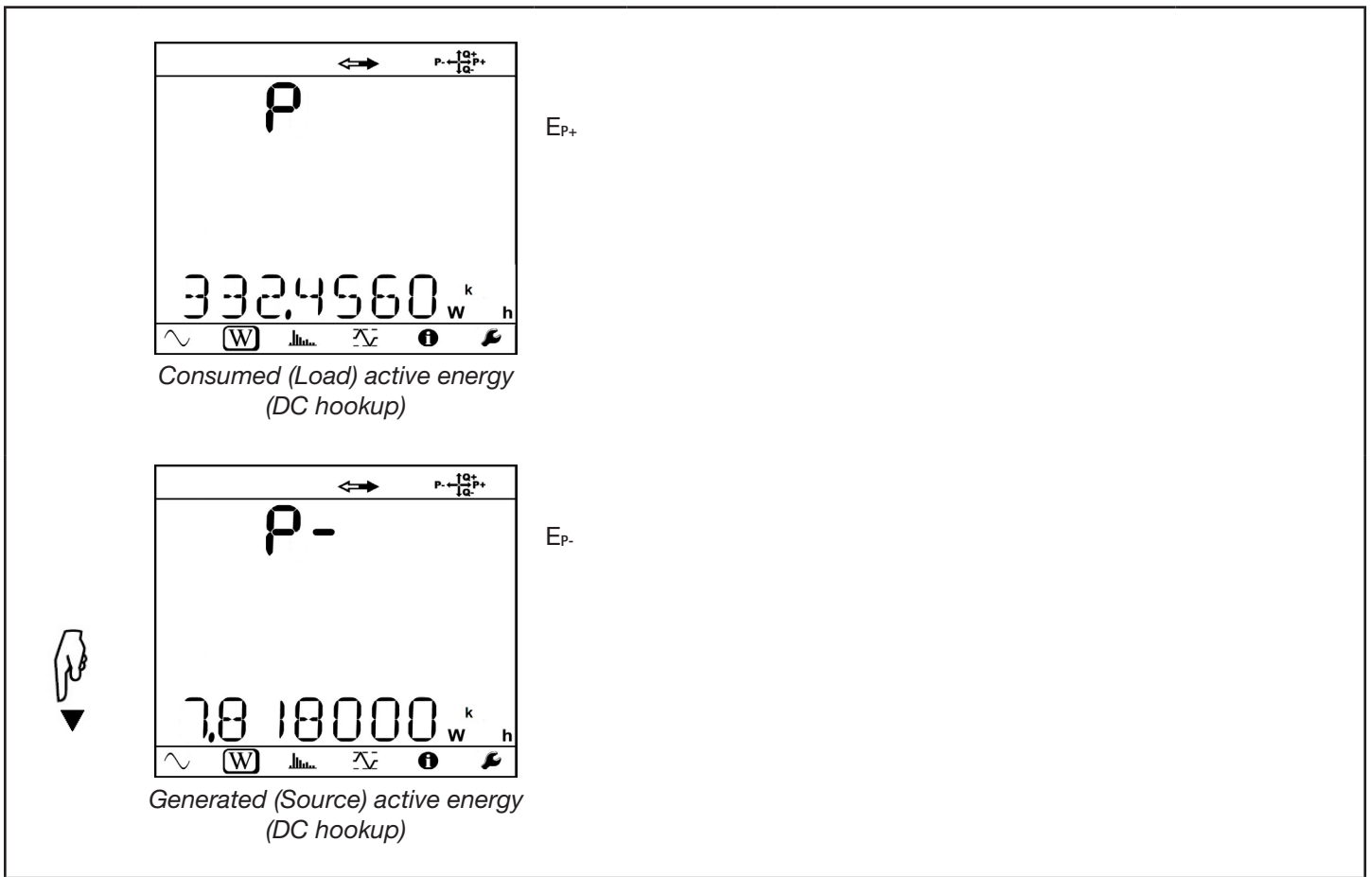

4.2.3 Harmonics Mode

Select the  icon to enter Harmonics mode. These screens display total harmonic distortion (THD) values for AC voltage and current. There are either one or two Harmonics mode screens, depending on hookup type.

 **NOTE:** Harmonics mode is not available for DC hookups.

4.2.3.1 1-Phase 2-Wire (1P-2W)

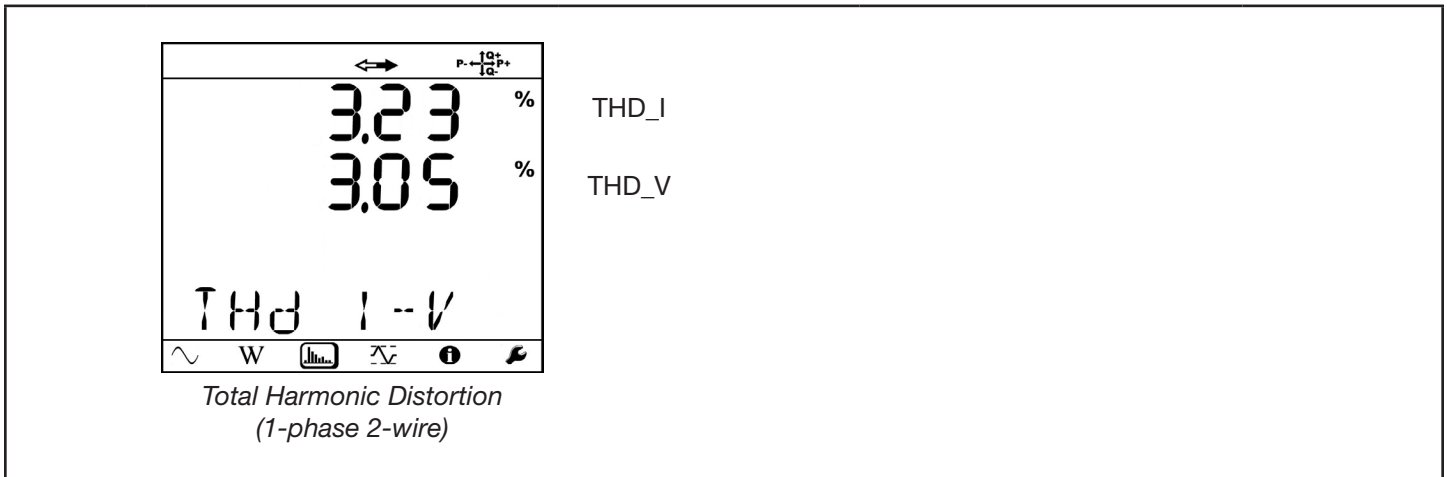

4.2.3.2 1-Phase 3-Wire (1P-3W)

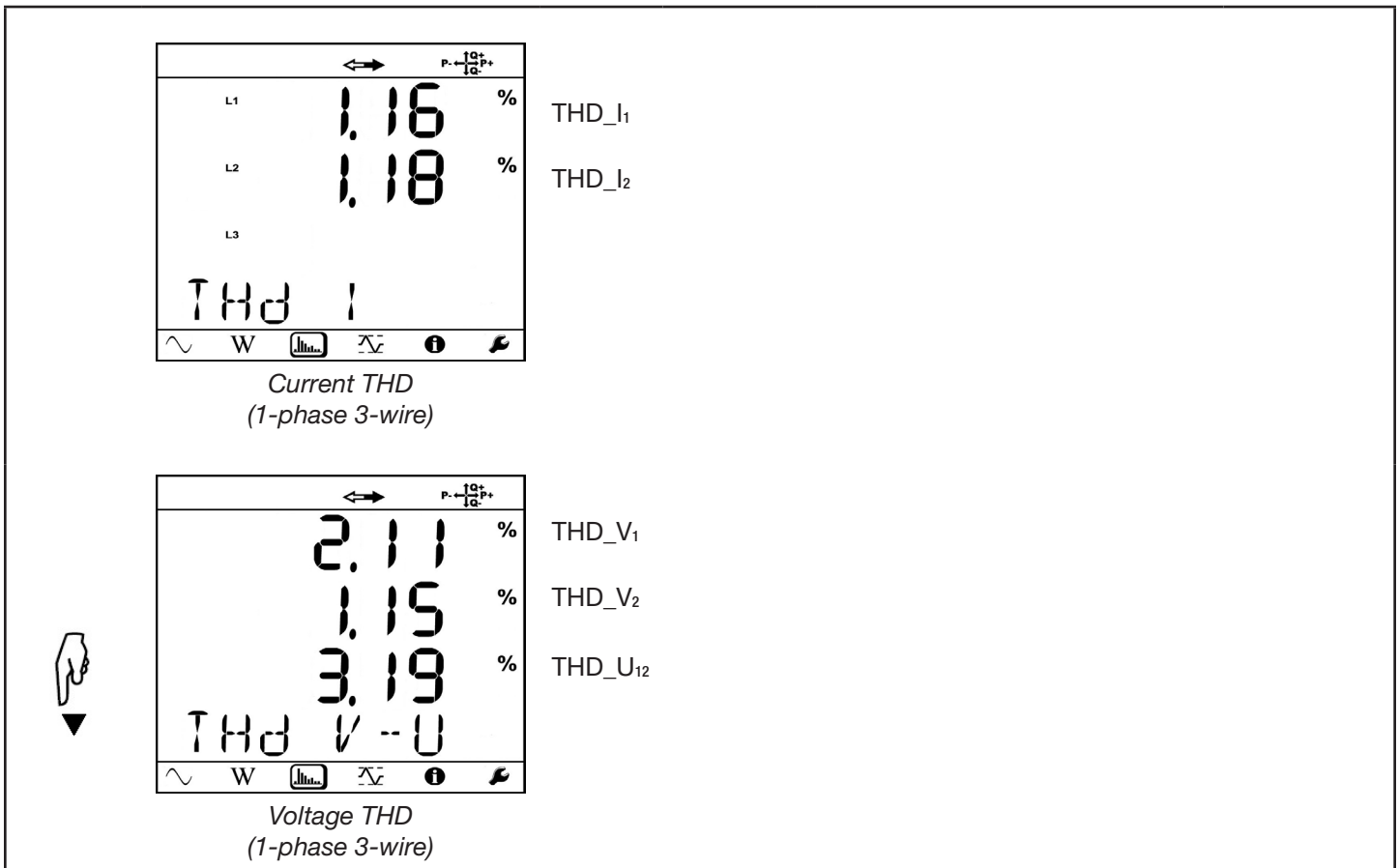

4.2.3.3 3-Phase 3-Wire Unbalanced

Two Harmonics mode screens appear when the hookup setting is one of the following:

- 3P-3W Δ 2 (3-phase 3-wire Δ , two probes)
- 3P-3W Δ 3 (3-phase 3-wire Δ , three probes)
- 3P-3WO2 (3-phase 3-wire open Δ , two probes)
- 3P-3WO3 (3-phase 3-wire open Δ , three probes)
- 3P-3WY2 (3-phase 3-wire Y, two probes)
- 3P-3WY3 (3-phase 3-wire Y, three probes)

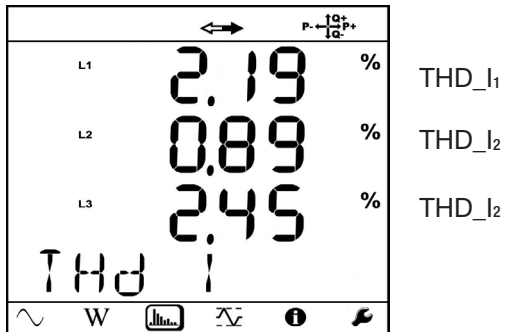

Current THD
(3-phase 3-wire unbalanced)

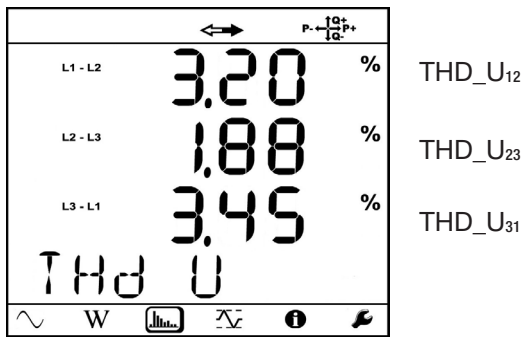

Voltage THD
(3-phase 3-wire unbalanced)

4.2.3.4 3-Phase 3-Wire Δ Balanced (3P-3W Δ b)

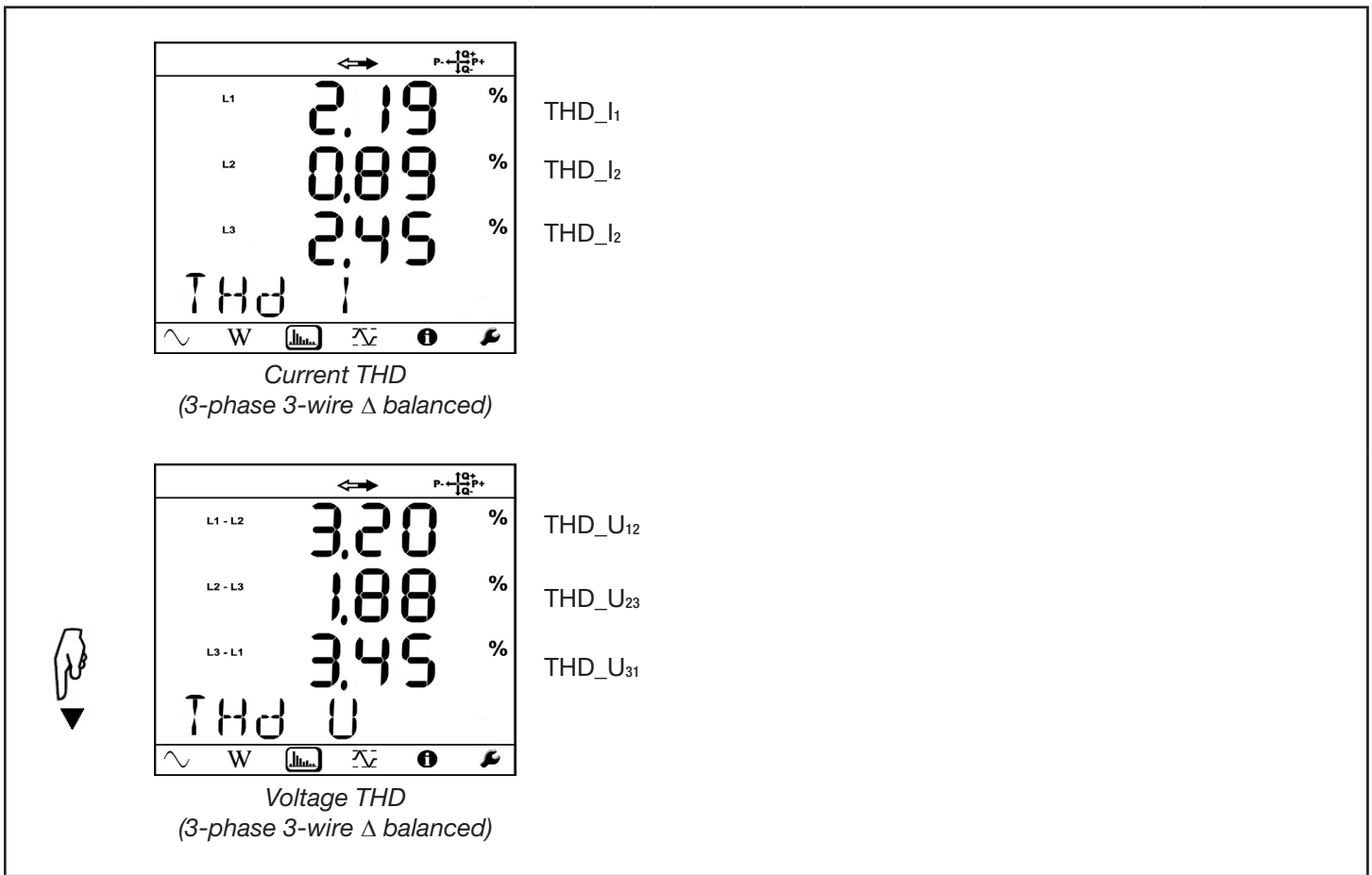

4.2.3.5 3-Phase 4-Wire Unbalanced

Two Harmonics mode screens appear when the hookup setting is one of the following:

- 3P-4WY (3-phase 4-wire Y)
- 3P-4WY2 (3-phase 4-wire Y, two probes)
- 3P-4W Δ (3-phase 4-wire Δ)
- 3P-4WO (3-phase 4-wire open Δ)

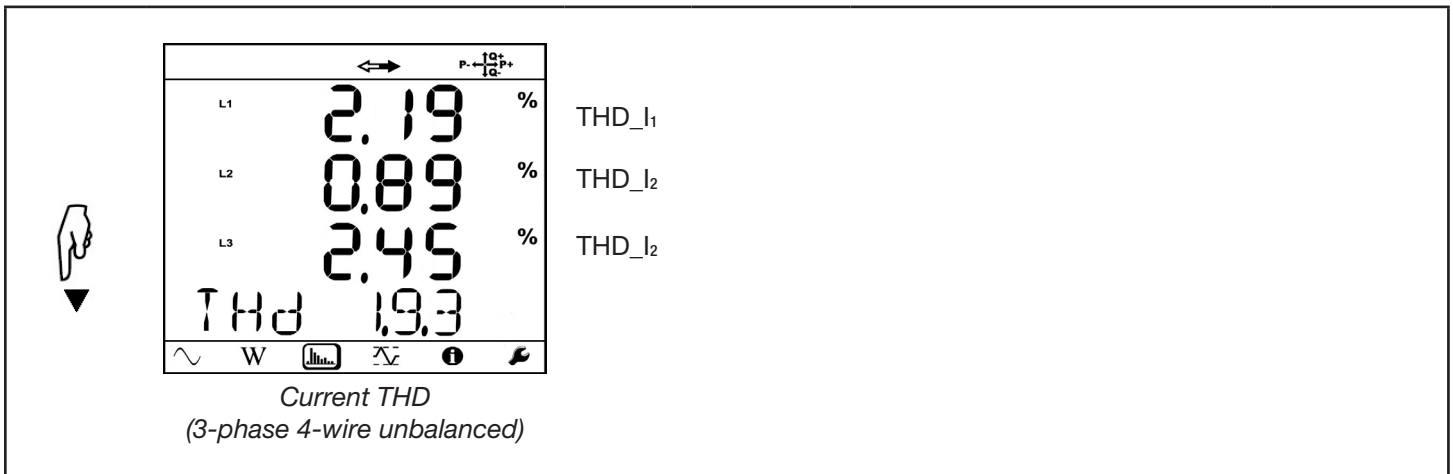

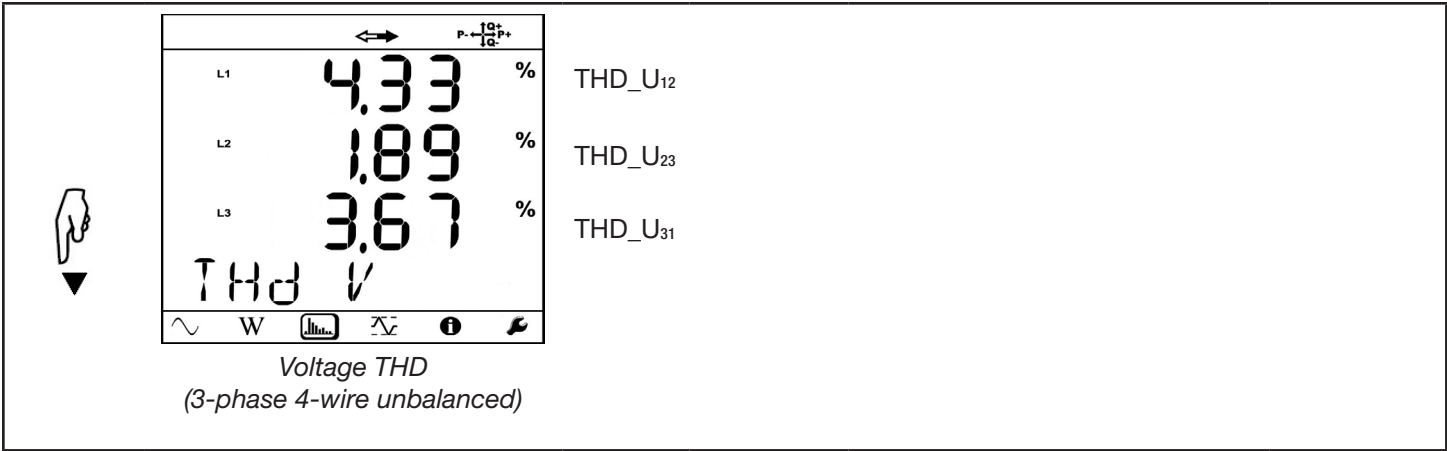

4.2.3.6 3-Phase 4-Wire Balanced (3P-4WYb)

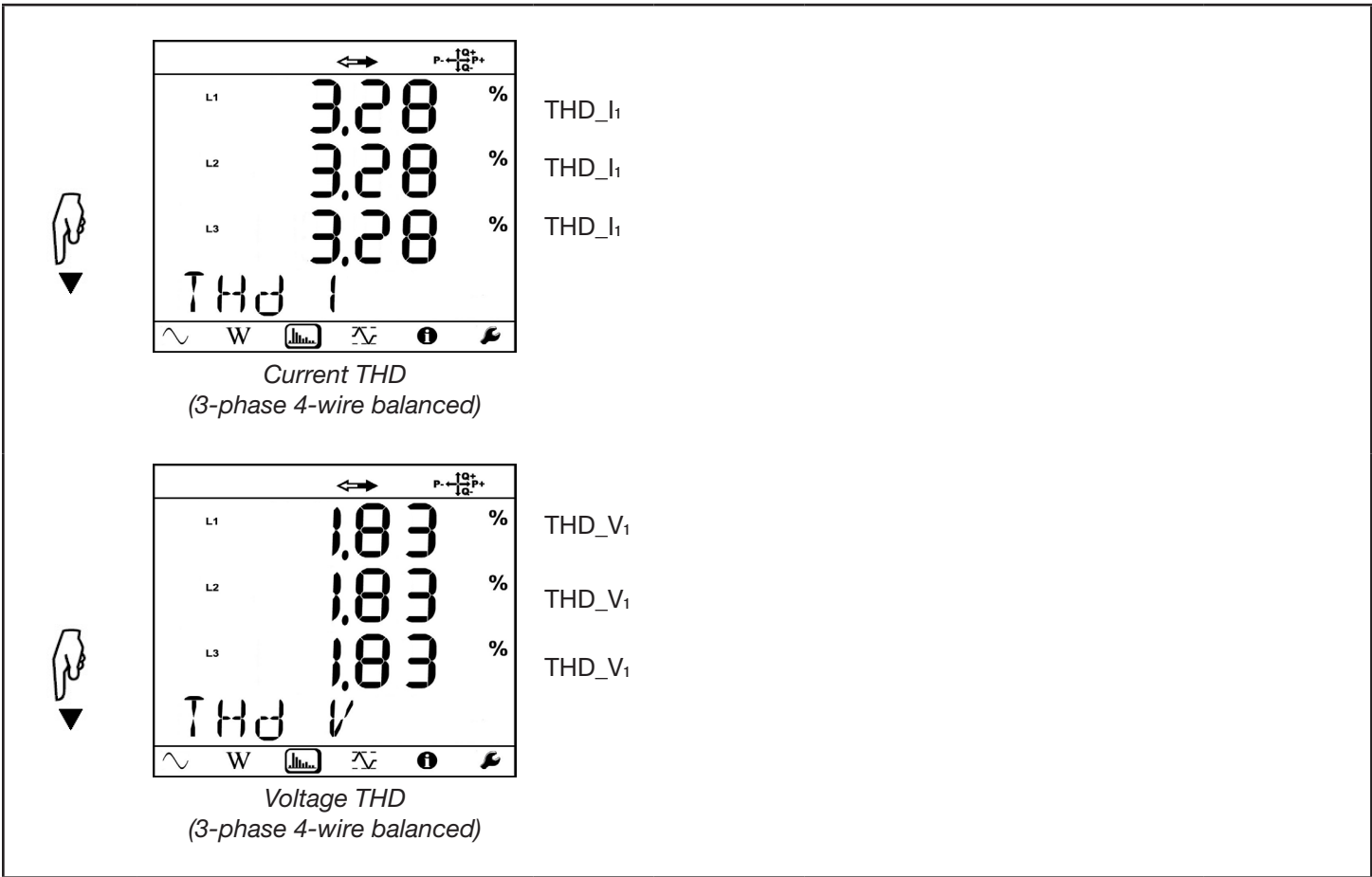

4.2.4 Maximum Mode

Select the  icon to enter Maximum mode. These screens display values for the maximum of the one second measurements during an aggregation period. This is reset either (1) when a new aggregation period starts, or (2) continuously, depending on how this setting is configured. You can also reset this value manually through the DataView PEL Control Panel. When no recording is in progress, these values represent the maximum of the one second measurements since the end of the last recording.

Note that Maximum mode is not available for DC power networks.

4.2.4.1 1-Phase 2-Wire (1P-2W)

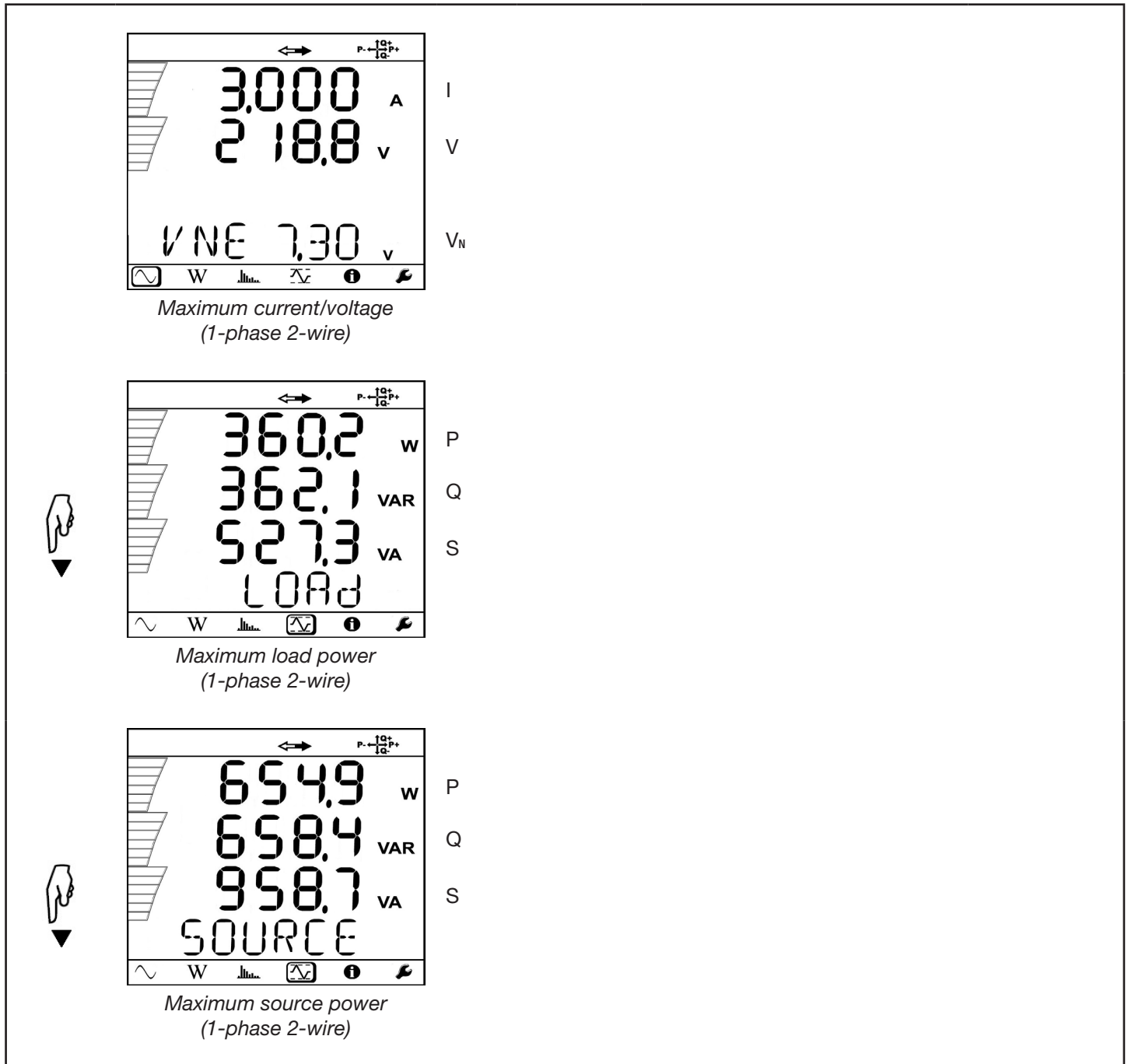

The figure displays three screenshots of the Maximum Mode interface for a 1-Phase 2-Wire configuration. Each screen shows a lightning bolt icon on the left and a hand icon pointing to a button on the left side of the screen. The top of each screen features a double-headed arrow and the text $P \sim \frac{I^2}{I_a^2}$.

Maximum current/voltage (1-phase 2-wire)

Measurement	Value	Unit
Current (I)	3.000	A
Voltage (V)	218.8	V
Neutral Voltage (V _N)	7.30	V

Maximum load power (1-phase 2-wire)

Measurement	Value	Unit
Power (P)	360.2	W
Reactive Power (Q)	362.1	VAR
Complex Power (S)	527.3	VA
Label	LOAD	

Maximum source power (1-phase 2-wire)

Measurement	Value	Unit
Power (P)	654.9	W
Reactive Power (Q)	658.4	VAR
Complex Power (S)	958.7	VA
Label	SOURCE	

4.2.4.2 1-Phase 3-Wire (1P-3W)

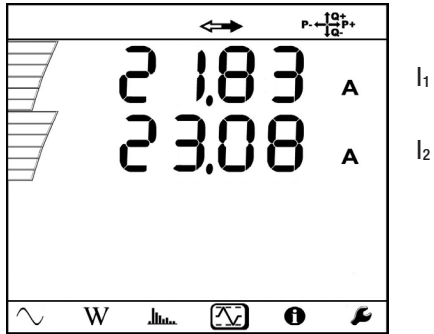

Maximum current
(1-phase 3-wire)

I_1
 I_2

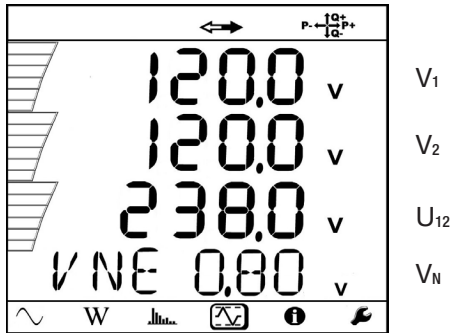

Maximum voltage
(1-phase 3-wire)

V_1
 V_2
 U_{12}
 V_N

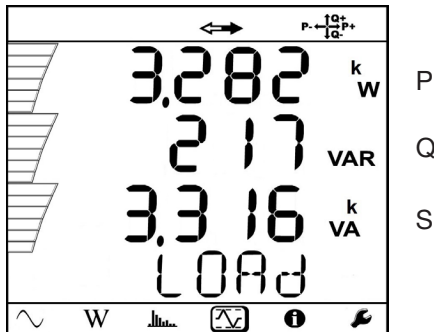

Maximum load power
(1-phase 3-wire)

P
Q
S

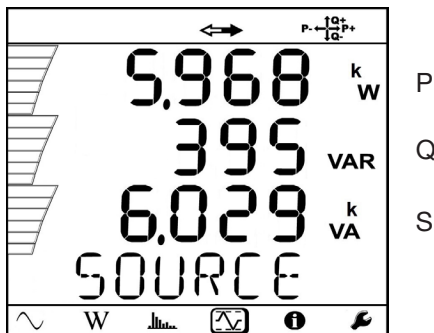

Maximum source power
(1-phase 3-wire)

P
Q
S

4.2.4.3 3-Phase 3-Wire

Four Maximum mode screens appear when the hookup type is one of the following:

- 3P-3W Δ 2 (3-phase 3-wire Δ , two probes)
- 3P-3W Δ 3 (3-phase 3-wire Δ , three probes)
- 3P-3WO2 (3-phase 3-wire open Δ , two probes)
- 3P-3WO3 (3-phase 3-wire open Δ , three probes)
- 3P-3WY2 (3-phase 3-wire Y, two probes)
- 3P-3WY3 (3-phase 3-wire Y, three probes)
- 3P-3W Δ b (3-phase 3-wire Δ balanced)

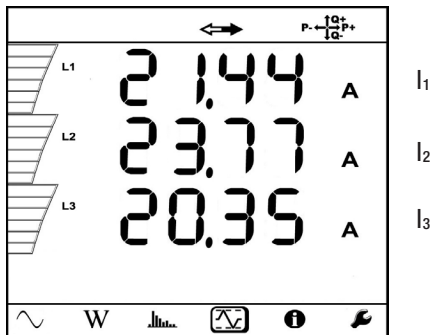

Maximum line current
(3-phase 3-wire)

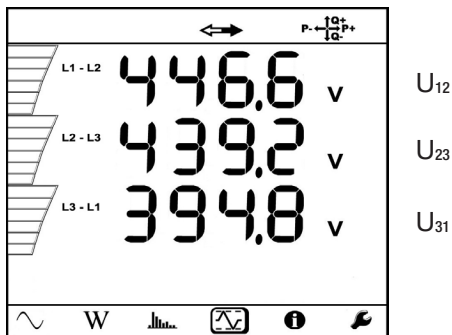

Maximum line voltage
(3-phase 3-wire)

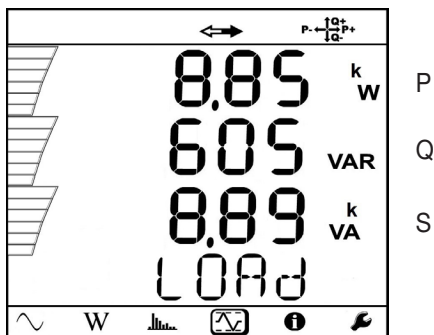

Maximum load power
(3-phase 3-wire)

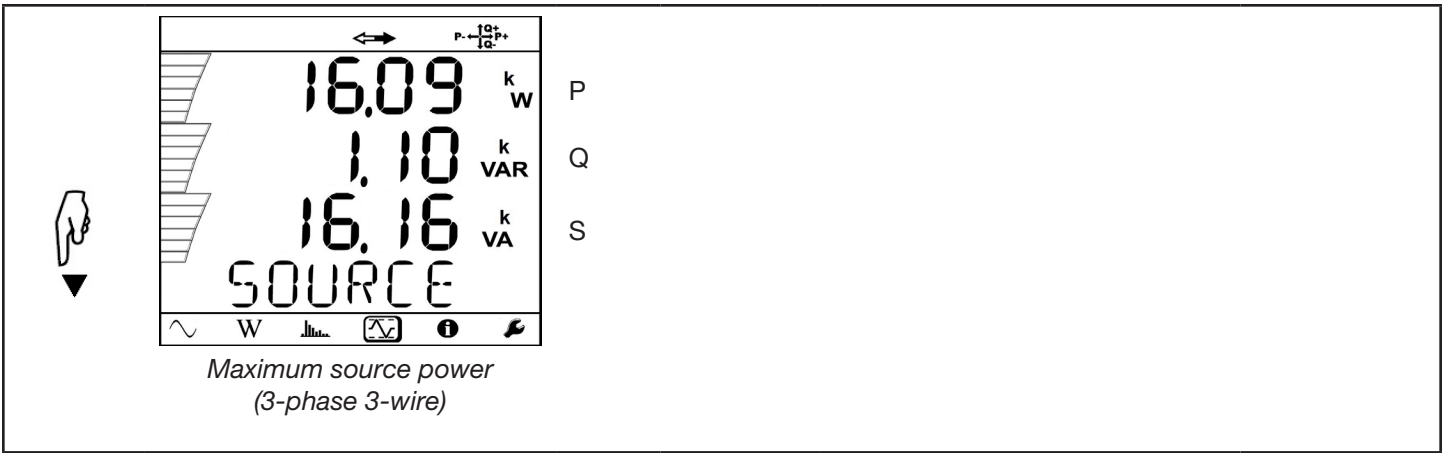

4.2.4.4 3-Phase 4-Wire

Four Maximum mode screens appear when the hookup type is one of the following:

- 3P-4WY (3-phase 4-wire Y)
- 3P-4WY2 (3-phase 4-wire Y, two probes)
- 3P-4WΔ (3-phase 4-wire Δ)
- 3P-4WO (3-phase 4-wire open Δ)

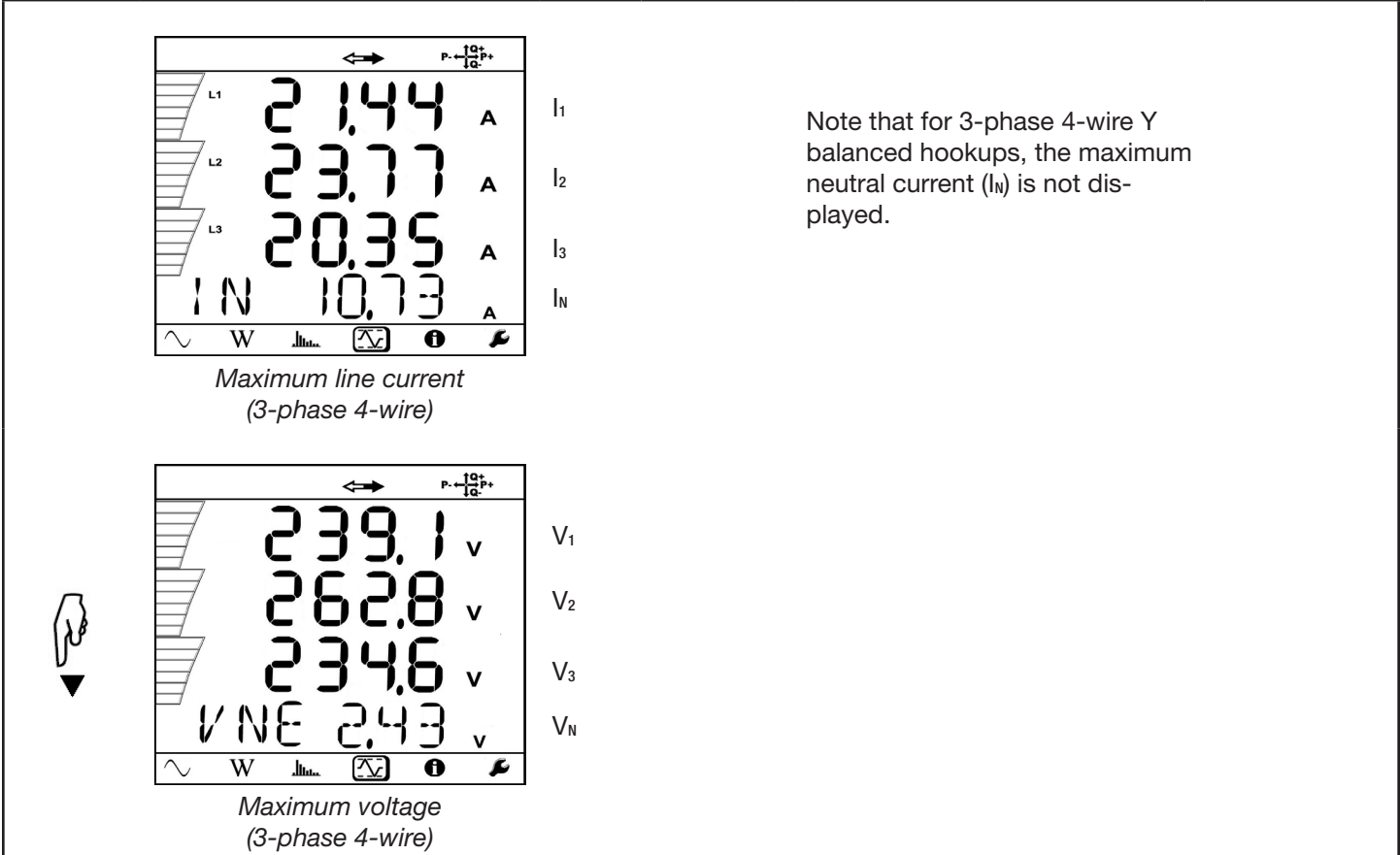

Note that for 3-phase 4-wire Y balanced hookups, the maximum neutral current (I_N) is not displayed.

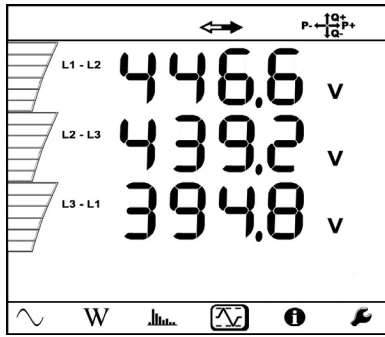

U₁₂

U₂₃

U₃₁

Max. phase-to-phase voltage
(3-phase 4-wire)

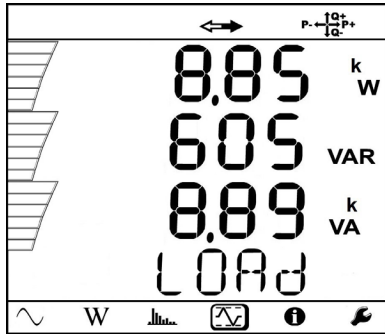

P

Q

S

Maximum load power
(3-phase 4-wire)

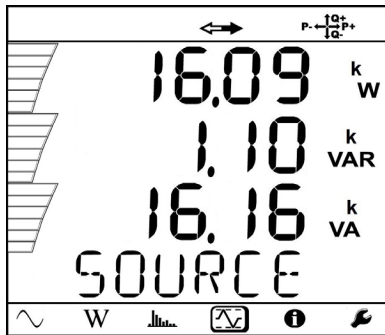

P

Q

S

Maximum source power
(3-phase 4-wire)

5. RECORDING DATA

The instrument can record measurement data and store the results. You can start a recording immediately, or (using the DataView PEL Control Panel) schedule one with a defined start date/time and duration. The session can then be downloaded for viewing, analysis, and distribution.

5.1 Recording Session Overview

Recording sessions are configured through the PEL Control Panel. This provides a number of recording options, such as selecting which data to include in the recording, the demand (aggregation) period, and recording schedule. This also includes changing the instrument's date and time, if required (see § 6.3). After you complete a recording session, you can add information such as session name, the operator who conducted the recording, and the location where it took place. In addition, the PEL Control Panel enables you to download recordings and clear them from the instrument.

Typically, recording sessions are started, stopped, and scheduled through the PEL Control Panel. You can also start and stop a recording session on the instrument itself (see § 5.2). You can also set the aggregation period for a recording, as explained in § 3.6.4.

Recording sessions are stored in the instrument's SD card. The memory required for a recording session primarily depends upon the duration of the recording and the storage period. Recording rates for the different types of session data are as follows:

- 200ms trends: 92MB per day
- 1-second harmonics: 91MB per day.
- 1-second trends: 18MB per day.
- Aggregated trend: 1.7MB per day for 1 minute periods. For longer periods, this rate is divided by the period in minutes. For example, for an aggregation period of 10 minutes, the rate will be 0.17MB per day; for 15 minute periods this is 0.113MB per day, and so on.
- Aggregated harmonics: 1.6MB per day for 1 minute periods. (For longer periods, use the same formula described above for aggregated trend data.)

For instance, a five-day session recording aggregated trends and harmonics with a 15 minute demand period, 1 second trends, and 1 second harmonics would consume approximately 636MB of storage.

The recommended maximum recording times for a single session on an instrument are:

- 21 days when recording 200-ms trends and 1-minute aggregated data (trend and harmonics).
- One month when recording 1-minute aggregated data, 1-second trends, and 1-second harmonics.
- 15 weeks when recording 1-minute aggregated data and 1-second trend data but not harmonics.
- Three years when recording only 1 minute aggregated data (including aggregated harmonics).
- Multiple years when recording only 15-minute aggregated data (without aggregated harmonics).

Other recommendations include:

- Do not store more than 32 recording sessions on the SD card.
- For recordings with harmonics or with a duration longer than one week, use class 4 or higher SDHC cards.
- Avoid downloading large sessions via Bluetooth, because this may require many hours to finish. If Bluetooth is the only communication method available, you can reduce the amount of data to be downloaded by selectively excluding 200ms trends, 1 second trends, and harmonics from the download. Doing so reduces the data downloaded from a 30 day recording with 15-minute aggregation to 3.4MB. (You can choose which recorded data to include/exclude in the download via the PEL Control Panel.)

5.2 Starting and Stopping a Recording

Before starting a recording, ensure that the instrument is not currently locked (the word LOCK appears on the screen in Configuration mode). The instrument cannot begin a recording when it is locked. The instrument is locked when:

- Being configured via the PEL Control Panel.
- Disabled through an option in the PEL Control Panel (see § 3.6).
- A recording session is already in progress. Note that in this case the  button remains active so you can stop the recording. However, you cannot start a new recording if one is in progress.





If any of these situations is in effect, take appropriate action as necessary to unlock the instrument. Then check the SD card  LED.

- **If the LED is green**, the SD card is ready to store recordings.
- **If the LED glows steady red**, ensure that:
 - The SD card is installed. If not, consult § 2.7.
 - The write-protect sliding tab on the card is in the “unlock” position (towards the metal contacts).
 - The SD card is formatted. Formatting can be performed either through the PEL Control Panel, or through a Windows command on your computer.

Note that the LED briefly blinks red when the card is initializing.

- **If the LED blinks alternately red and green**, the SD card is full. Download any data you want to save to your computer, then erase the content of the card through the PEL Control Panel.

When the  LED indicates the SD card is ready, you can begin recording. To do this through the PEL Control Panel, follow the instructions provided in the PEL Control Panel Help system. To record through the instrument user interface, do the following:

1. Press  and hold it down until the **REC** LED lights. Then release .
2. The **REC** LED should now blink twice every five seconds, indicating a recording is in progress.
3. To stop a recording, press  and hold it down until the **REC** LED lights up, then release .

To view the recording session, connect the instrument to your computer running DataView (see § 6).

6. DATAVIEW® & PEL CONTROL PANEL

DataView enables a computer to connect to and interact with a variety of AEMC instruments, including the Model PEL 105. As its name implies, the primary purpose of DataView is to view data that has been recorded by the instrument and display it as a report.

With DataView, you can:

- Connect the instrument to a computer. This connection can be through USB cable, LAN network, direct Ethernet connection, Wi-Fi, or Bluetooth.
- Display and analyze real-time data on the computer via a frames style interface.
- Download previously recorded data from the instrument. You need DataView to view recording sessions, since these sessions cannot be displayed through the instrument's interface.
- Start, schedule, stop, and cancel a recording session.
- Configure a wide variety of instrument settings.
- Perform instrument maintenance such as formatting the SD card and erasing its content.
- Generate reports for viewing and printing the data, using standard templates or ones you customize to your requirements.

DataView includes a core set of features used by all instruments. These features are designed for viewing data, and for opening, creating, and saving reports. DataView also includes components called Control Panels for interacting with the instrument. A Control Panel lets you connect to the instrument, download data, and configure the instrument's settings. Each AEMC product family has its own dedicated Control Panel; you select the one(s) you need during DataView installation.

For example, DataView includes the PEL Control Panel specifically designed for working with Model PEL Series instruments. The PEL Control Panel provides all the features available in the instrument's user interface, as well as many additional features.

6.1 Installing DataView

When you purchase the instrument, the product package includes a USB thumb drive containing DataView program files. To begin installation:

1. Insert the DataView thumb drive into an available USB port on your computer. If Autorun is enabled, an AutoPlay window appears on your screen. Click “Open folder to view files” to display the DataView folder. If Autorun is not enabled or allowed, use Windows Explorer to locate and open the USB drive labeled “DataView.”
2. When the DataView folder is open, find the file Setup.exe located in the root directory of the USB drive, and double-click it to run the installation program.
3. The DataView setup screen appears.

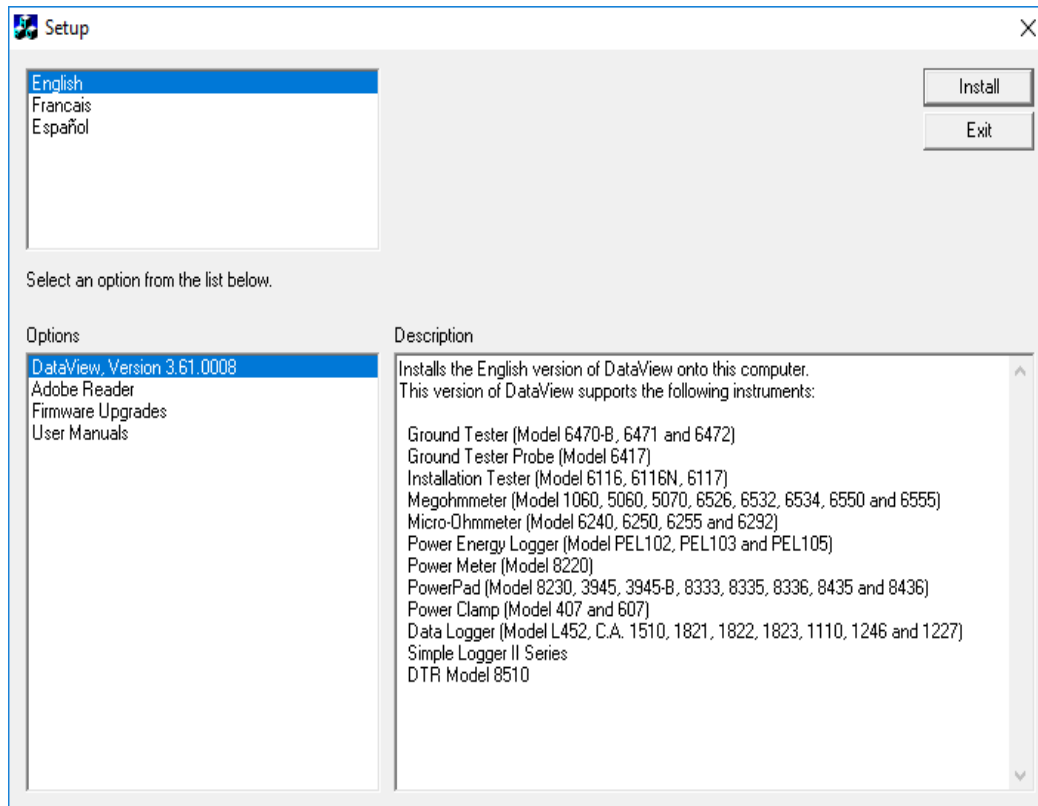

Figure 31

In the upper left corner of the screen, choose the language version of the Setup interface. (All Setup screens and dialogs will immediately appear in the selected language.)

In the lower left corner are the available installation options. In addition to the DataView software, you can select “Adobe Reader.” This links to the Adobe web site where you can download the latest version of Reader. This program is required to view DataView .pdf documents. The option Firmware Upgrades links to the website where you can check for new firmware updates for the PEL 105 (see § 8.1.2). Finally, User Manuals displays a list of .pdf files contained in the USB drive that accompanies DataView. (DataView also comes with a Help system that is installed with the program files.)

To install DataView, select DataView in the Options list and click Install.

4. After a few moments a screen appears asking you whether or not you want to allow the DataView Setup program to make changes to your computer. Click OK.

5. Select the language version of DataView you want to install (English, French, or Spanish) then click Next. (By default, the language selected in step 3 is highlighted.)

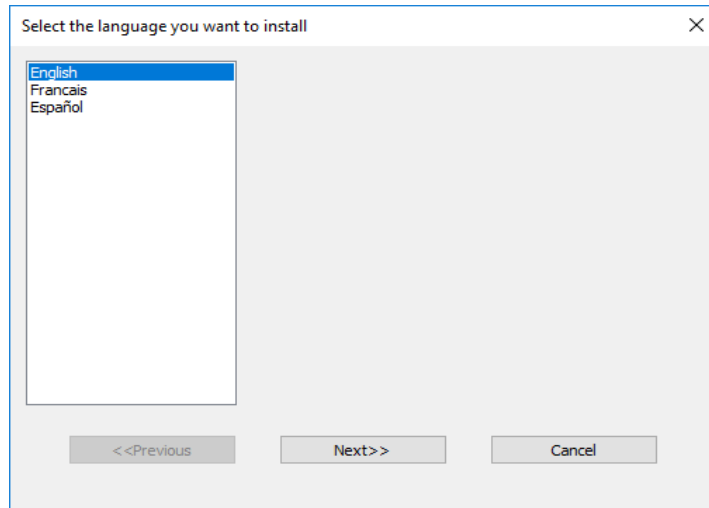

Figure 32

6. You are now prompted to select the software you want to install.

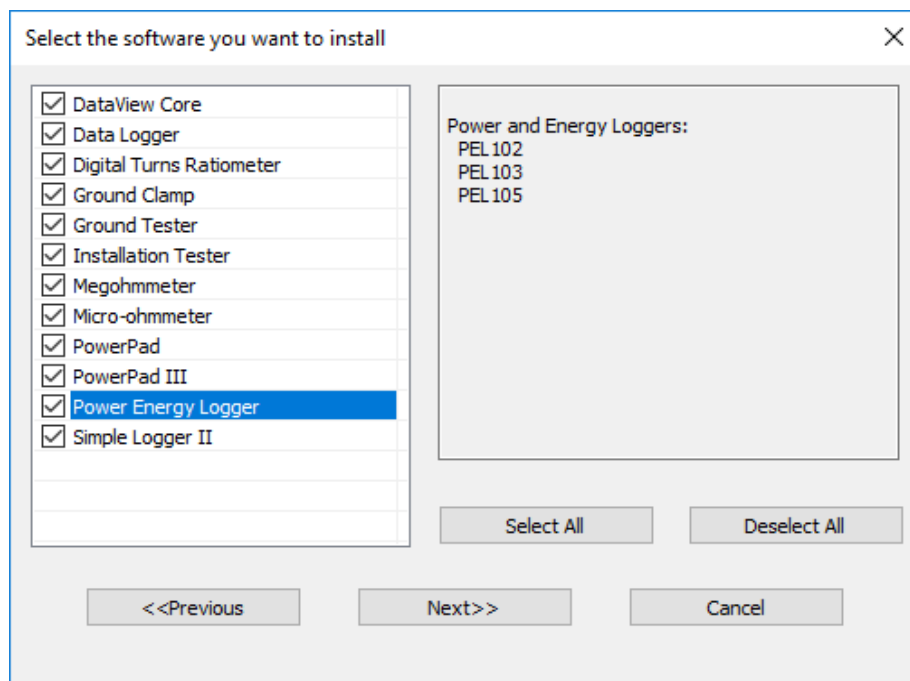

Figure 33

Each AEMC product family has its own specially designed Control Panel. If you are performing a Complete install, by default all available Control Panels are selected (a check mark next to the Control Panel indicates it is selected). Control Panels take up disk space on the computer; so unless you have other types of AEMC instruments, we recommend that you select Power Energy Logger and deselect the rest. You should also check the option DataView Core, which is a requirement if you plan to create DataView reports.

After you finish selecting and deselecting Control Panels and/or DataView Core, click Next.

7. The Setup program now informs you that it is ready to install DataView. If you want to review any of your previous selections, click the Previous button to return to earlier screens. Otherwise, click Install to begin installation.
8. The InstallShield program installs the selected software. If an earlier version of the software is already installed on your computer, for each selected program the InstallShield program will:
 - (a) Ask you to confirm the installation of the program. Click Next.
 - (b) Display a status bar indicating the progress of the installation.
 - (c) Inform you when the program is installed. Click Finish to install the next selected program.

If the software is not installed (or if the installed software is the same version as the selected software), the software is installed without requesting confirmation.

When all programs are installed, a message appears informing you of this. Click Finish to return to the Setup screen.

9. You can now select additional Setup options to install (see step 3 above). When finished, click Exit.
10. The DataView folder now appears on your computer desktop, within which is the PEL Control Panel icon  and the icon(s) for any other Control Panel(s) you have installed.

6.2 The PEL Control Panel

Clicking the DataView icon in the DataView folder on your desktop opens the core DataView program. Clicking the PEL Control Panel icon opens the PEL Control Panel:

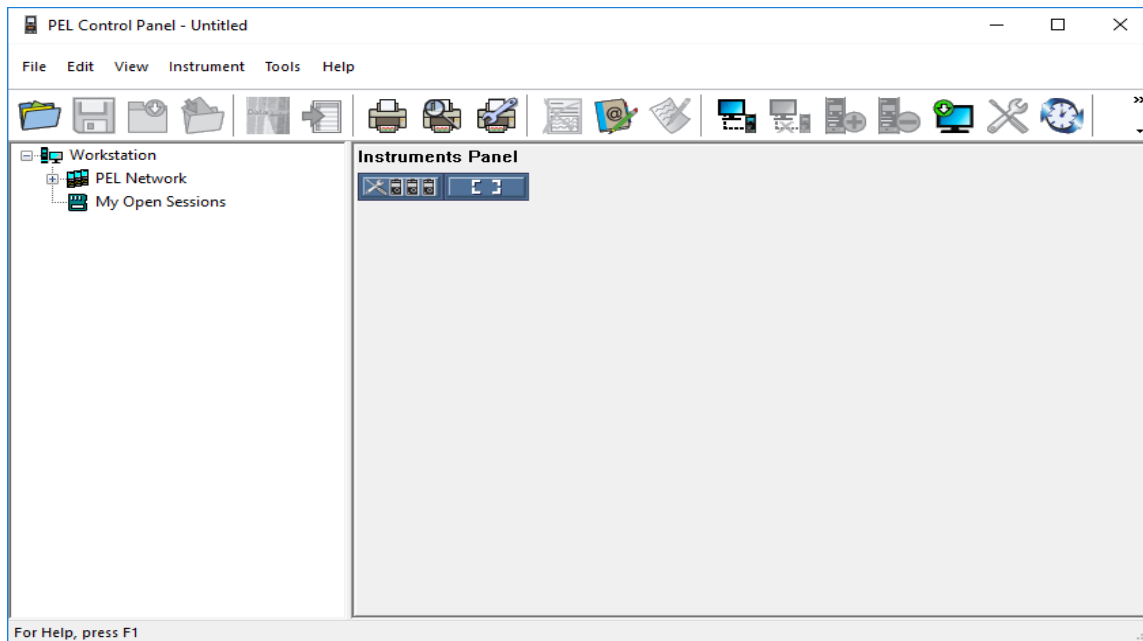

Figure 34

In general, core DataView features are for creating, viewing, editing, and storing DataView reports; while the PEL Control Panel is for connecting to, configuring, viewing measurements on, and downloading data from the instrument. You can access all DataView features through either the DataView icon or the Control Panel icon. For users who interact with PEL 100 series instruments, we recommend primarily using the PEL Control Panel. However, there are situations where using the core DataView icon may be more convenient for some users, such as when viewing multiple archived reports from different AEMC product families.

For further information about using the PEL Control Panel, consult the Help system that comes with the product. Access this Help by clicking the option Help in the PEL Control Panel's menu bar at the top of the screen.

6.3 Connecting to the Computer

Before you can use the PEL Control Panel to communicate with your instrument, you must establish a connection between the instrument and the computer. There are six types of connections available:

- USB cable connection
- Bluetooth wireless connection
- Wi-Fi direct connection
- Ethernet point-to-point cable connection
- Network connection via LAN or Wi-Fi
- Network connection via IRD server

To begin, ensure that you have installed DataView with the PEL Control Panel. Also ensure that the required communication and connection drivers are installed on your computer. These drivers are installed as part of the DataView installation process.

After the instrument is successfully connected, consult the PEL Control Panel Help system for instructions about viewing real-time data on the instrument, downloading and viewing recorded sessions, creating DataView reports from the downloaded data, and configuring the instrument.



6.3.1 USB

USB is typically used for connecting a single local instrument. A USB cable comes as part of the instrument's product package. To begin the connection process:

1. Plug one end of the cable into the instrument, and the other end into an available USB port on the computer. The first time the instrument is connected via USB, drivers will be installed. Wait for the drivers to finish installing before proceeding.
2. With the instrument connected, open the PEL Control Panel (see previous illustration).
3. In the menu bar at the top of the screen, select Instrument.
4. In the drop-down menu that appears, click the option Add an Instrument. This opens the Add an Instrument Wizard dialog box.
5. Select USB as the connection type, and complete the Add and Instrument dialog. If you need assistance, press the Help button.

Note that USB connection is always available and enables you to change instrument configuration settings at any time.

6.3.2 Bluetooth



Bluetooth is a standard for wirelessly connecting devices over short distances. This is especially useful for connecting multiple local instruments to a computer, since unlike USB it does not require a physical connection port for each instrument. The PEL 105 includes built-in Bluetooth capability. To use this feature to connect to a computer, Bluetooth must be enabled on the instrument. Check the Bluetooth  LED. If it is OFF, press  and hold it down until the  LED lights up. Then release the button to enable Bluetooth.

Your computer must also be Bluetooth-enabled. Some computers have Bluetooth connectivity built in, while others require a Bluetooth-USB adapter. When this adapter is plugged into a USB port and configured with the appropriate driver, the computer can communicate via Bluetooth. When the computer is Bluetooth-ready, connect the instrument as follows:

1. Open the Bluetooth Devices dialog on your computer to pair the instrument with your computer. Different operating systems have different steps for opening this dialog, so consult your computer's documentation for instructions.
2. When the dialog is displayed, click Add a Device. A dialog box appears listing the locally available Bluetooth devices. There may be several devices of varying types listed, depending on the location of your computer.

3. Find the instrument, which will appear listed by its Bluetooth name. This name consists of the prefix “PEL 105” plus any additional characters you add via the PEL Control Panel. Click the name.
4. You are prompted to enter a pairing code, which for PEL 105 instruments is always 0000. After you enter the code, click Next.
5. A screen appears informing you that the instrument has been successfully connected with the computer. Click Close to exit the screen.
6. Open the PEL Control Panel. In the menu bar at the top of the screen, select Instrument.
7. In the drop-down menu that appears, click the option Add an Instrument. This opens the Add an Instrument Wizard dialog box.
8. Select Bluetooth as the connection type, and complete the Add and Instrument dialog. If you need assistance, press the Help button.

6.3.3 Wi-Fi Direct Connection



The PEL 105 can also connect via Wi-Fi, either directly to the computer or via a router (see § 6.3.6). To directly connect, Wi-Fi must be enabled on the instrument. Check the Wi-Fi  LED. If it is glowing steadily or blinking, Wi-Fi is enabled. If it is OFF, press  and hold it down until the  LED lights up. Then release the button to enable Wi-Fi.

If you direct-connect to the instrument with Wi-Fi, your computer must also be Wi-Fi-enabled.

Before you can connect through the PEL Control Panel, you must create a connection between the computer and instrument in Microsoft Windows. A direct Wi-Fi connection requires the instrument’s SSID number and (if required) password, which you can define by connecting the instrument via USB cable, opening the Control Panel, and displaying the Configure dialog box, as instructed by the Control Panel Help. The Configure dialog box includes fields for setting Wi-Fi connection options.

When this connection is established, open the PEL Control Panel and complete the following steps:



1. In the menu bar at the top of the screen, select Instrument.
2. In the drop-down menu that appears, click the option Add an Instrument.
3. Select Wi-Fi direct as the connection type, and complete the Add and Instrument dialog. If you need assistance, press the Help button.

Note that during this process you will be prompted to select the instrument via its Wi-Fi IP address. Each PEL 105 comes with a Wi-Fi IP address, which you can view by entering Information  mode and pressing  until the Wi-Fi address is displayed.

6.3.4 Point-to-Point Ethernet Cable

Another connection option is Ethernet cable. To use this connection method, your computer must be equipped with an available Ethernet port. You must also have an Ethernet cable (purchased separately).

1. Plug one end of the Ethernet cable into the instrument, and the other end into the Ethernet port on the computer.
2. With the instrument connected, open the PEL Control Panel.
3. In the menu bar at the top of the screen, select Instrument.
4. In the drop-down menu that appears, click the option Add an Instrument. This opens the Add an Instrument Wizard dialog box.
5. Select Point-to-point Ethernet cable (APIPA mode) as the connection type, and complete the Add and Instrument dialog. If you need assistance, press the Help button.

Note that during this process you will be prompted to select the instrument’s IP address. Each PEL 105 has a default IP address, which you can view by entering Information  mode and pressing  until the IP address is displayed.

6.3.5 Ethernet Network via LAN or Wi-Fi

The PEL Control Panel can connect to a PEL 105 through a network. To do this, the instrument must be connected to a network accessible to the computer. The network connection can be either via LAN or Wi-Fi router. Consult your network administrator if you need assistance with this. When this connection is established, open the PEL Control Panel. Then do the following:

1. In the menu bar at the top of the screen, select Instrument.
2. In the drop-down menu that appears, click the option Add an Instrument.
3. Select Ethernet (LAN or Wi-Fi) as the connection type, and complete the Add and Instrument dialog. If you need assistance, press the Help button.

Note that during this process you will be prompted to select the instrument's IP address. Each PEL 105 has a default IP address, which you can view by entering Information  mode and pressing ▼ until the IP address is displayed. (The instrument can also automatically obtain an IP address from a DHCP server on the network to which it is connected.)

6.3.6 Network via IRD Server

An IRD server allows you to connect your computer to instruments on different networks. You must first connect the instrument to a network that can access the internet. Consult your network administrator if you need assistance with this. When this connection is established, open the PEL Control Panel. Then do the following:

1. In the menu bar at the top of the screen, select Instrument.
2. In the drop-down menu that appears, click the option Add an Instrument.
3. Select IRD server as the connection type, and complete the Add and Instrument dialog. If you need assistance, press the Help button.

Note that during this process you will be prompted to enter the instrument's serial number and password. This information is provided on a label attached to the instrument when it first ships.

6.4 Setting Date and Time

As explained in § 3.6, you can view the instrument's date and time in Information  mode, but you cannot change this information through the instrument's interface. To change the instrument's date/time, open the PEL Control Panel and do the following:

1. Ensure that the instrument is connected by checking its status in the PEL Network frame (a green check mark appears next to its name). If not, reconnect it by highlighting the instrument, selecting Instrument in the menu bar, and clicking Reconnect Instrument.
2. Select the instrument, and click Instrument in the menu bar.
3. Select Configure. This displays the Configure Instrument dialog box.
4. Click the Set Clock button. This displays a dialog for setting the date and time on the instrument.
5. You can synchronize the instrument's clock with the computer's clock, or use the Date and Time fields to select another date and time.
6. Click OK to save the change.

7. SPECIFICATIONS

7.1 Reference Conditions

Parameter	Reference Conditions
Ambient temperature	23°C ± 2° (73°F ± 3.6°)
Relative humidity	45% to 75% RH
Voltage	No DC component in AC, no AC component in DC (< 0.1%)
Current	No DC component in AC, no AC component in DC (< 0.1%)
Distribution system frequency	50Hz ± 0.1Hz and 60Hz ± 0.1Hz
Current-to-voltage phase	0° (active power) and 90° (reactive power)
Harmonics	< 0.1%
Voltage unbalance	0%
Internal temperature	Warm up: 1 hour
Common mode	Neutral input and enclosure are held at ground (earth) potential
	PEL 105 powered on battery, USB disconnected
Magnetic field	0 A/m AC
Electric field	0 V/m AC

Table 1

7.2 Electrical Specifications

7.2.1 Voltage Inputs

- **Operating range:** Up to 1000V_{RMS} for phase-to-neutral, phase-to-phase, and neutral-to-ground voltages at 50-60Hz (600V at 400Hz and DC). Note that phase-to-neutral voltages lower than 2V and phase-to-phase voltages lower than $(2 \times \sqrt{3})V$ are zeroed.
- **Input impedance:** 1908kΩ (phase-to-neutral and neutral-to-ground)
- **Max permanent overload:** 1100VRMS

7.2.2 Current Inputs

- **Operating range:** Up to 1.2V ($1V = I_{nom}$) with crest factor = $\sqrt{2}$
- **Input impedance:** 1MΩ (standard current input), 12.4kΩ (AmpFlex®/MiniFlex® current input). The AmpFlex®/MiniFlex® configuration switches the current input onto an integrating circuit. Sensitivity is 39.1μV/A at 50Hz, 46.93μV/A at 60Hz, and 312.8μV/A at 400Hz.
- **Max overload:** 1.7V

7.2.3 Measurement Ranges

7.2.3.1 Measurement Specifications at 50/60Hz

Quantity	Unit	Measurement range	Accuracy
Frequency (f)	Hz	42.5 to 69Hz	± 0.1Hz
Phase-to-Neutral voltage (V)	V	10 to 1000V	± (0.2% Rdg + 0.2V)
Neutral-to-Ground/Earth voltage (V_{PE})	V	10 to 1000V	± (0.2% Rdg + 0.2V)
Phase-to-phase voltage (U)	V	17 to 1000V	± (0.2% Rdg + 0.4V)
Current (I)	A	0.2 to 120% I_{nom}	± (0.2% Rdg + 0.02% I_{nom})
Neutral current (I_N)	A	0.2 to 120% I_{nom}	± (0.2% Rdg + 0.02% I_{nom})
Active Power (P)	W	PF = 1 V = 100 to 1000V I = 5 to 120% I_{nom}	± (0.5% Rdg + 0.005% P_{nom})
		PF = 0.5 inductive 0.8 capacitive V = 100 to 1000V I = 5 to 120% I_{nom}	± (0.7% Rdg + 0.007% P_{nom})
Reactive Power (Q)	var	Sin ϕ = 1 V = 100 to 1000V I = 5 to 120% I_{nom}	± (1% Rdg + 0.01% Q_{nom})
		Sin ϕ = 0.5 inductive; 0.5 capacitive V = 100 to 1000V I = 5 to 120% I_{nom}	± (1.5% Rdg + 0.01% Q_{nom})
		Sin ϕ = 0.25 inductive; 0.25 capacitive V = 100 to 1000V I = 10 to 120% I_{nom}	± (1.5% Rdg + 0.015% Q_{nom})
Apparent Power (S)	VA	V = 100 to 1000V I = 5 to 120% I_{nom}	± (0.5% Rdg + 0.005% S_{nom})
Power Factor (PF)	-	PF = 0.5 inductive; 0.5 capacitive V = 100 to 1000V I = 5 to 120% I_{nom}	± 0.05
		PF = 0.2 inductive; 0.2 capacitive V = 100 to 1000V I = 5 to 120% I_{nom}	± 0.1
Tan ϕ	-	Tan ϕ = $\sqrt{3}$ inductive; $\sqrt{3}$ capacitive V = 100 to 1000V I = 5 to 120% I_{nom}	± 0.02
		Tan ϕ = 3.2 inductive; 3.2 capacitive V = 100 to 1000V I = 5 to 120% I_{nom}	± 0.05

Active energy (E_p)	Wh	PF = 1 V = 100 to 1000V I = 5 to 120% I_{nom}	$\pm 0.5\%$ Rdg
		PF = 0.5 inductive; 0.8 capacitive V = 100 to 1000V I = 10 to 120% I_{nom}	$\pm 0.7\%$ Rdg
Reactive energy (E_0)	varh	Sin $\varphi = 1$ V = 100 to 1000V I = 5 to 120% I_{nom}	$\pm 2\%$ Rdg
		Sin $\varphi = 0.5$ inductive; 0.5 capacitive V = 100 to 1000V I = 5 to 120% I_{nom}	$\pm 2.5\%$ Rdg
Apparent energy (E_s)	VAh	V = 100 to 1000V I = 5 to 120% I_{nom}	$\pm 0.5\%$ Rdg
Fundamental Harmonic Distortion Rate (THDF)	%f	V = 100 to 1000V I = 10 to 120% I_{nom}	$\pm 1\%$ Rdg

In the preceding table:

- Rdg = Reading (displayed value).
- I_{nom} is the nominal current of the selected current probe.
- P_{nom} and S_{nom} are the Active Power and the Apparent Power for V = 1000V, I = I_{nom} , and PF = 1.
- Q_{nom} is the Reactive Power for V = 1000V, I = I_{nom} , and Sin $\varphi = 1$.
- The uncertainty for input current (I) is specified for an isolated input voltage of 1V = I_{nom} . The accuracy of the connected current probe should be added to this uncertainty to determine the total uncertainty. For MiniFlex® and AmpFlex® probes, the uncertainty of current input (I) is not specified.
- When there is no current probe, the uncertainty for neutral current I_N is the sum of the uncertainties on I_1 , I_2 , and I_3 .

Table 2

7.2.3.2 Measurement Specifications at 400Hz

Quantity	Unit	Measurement range	Accuracy
Frequency (F)	Hz	340 to 460Hz	$\pm 0.3\text{Hz}$
Phase-to-Neutral voltage (V)	V	5 to 600V	$\pm (0.2\% \text{ Rdg} + 0.5\text{V})$
Neutral-to-Ground/Earth voltage (V_{PE})	V	4 to 600V	$\pm (0.2\% \text{ Rdg} + 0.5\text{V})$
Phase-to-phase voltage (U)	V	10 to 600V	$\pm (0.2\% \text{ Rdg} + 0.5\text{V})$
Current (I)	A	0.2 to 120% I_{nom}	$\pm (0.5\% \text{ Rdg} + 0.05\% I_{nom})$
Neutral current (I_N)	A	0.2 to 120% I_{nom}	$\pm (0.5\% \text{ Rdg} + 0.05\% I_{nom})$

Active Power (P)	W	PF = 1 V = 100 to 600V I = 5 to 120% I _{nom}	± (2% Rdg + 0.2% P _{nom}) ^①
		PF = 0.5 inductive 0.8 capacitive V = 100 to 600V I = 5 to 120% I _{nom}	± (3% Rdg + 0.3% P _{nom}) ^①
Active energy (E _p)	kWh	PF = 1 V = 100 to 600V I = 5 to 120% I _{nom}	± 2% Rdg ^①

In the preceding table:

- Rdg = Reading (displayed value).
- I_{nom} is the value of the measured current for a current probe output of 1V.
- P_{nom} is the Active Power for V = 600V, I = I_{nom}, and PF = 1.
- The uncertainty for input current (I) is specified for an isolated input voltage of 1V = I_{nom}. The accuracy of the connected current probe should be added to this uncertainty to determine the total uncertainty. For MiniFlex[®] and AmpFlex[®] probes, the uncertainty of current input (I) is not specified.
- When there is no current probe, the uncertainty for neutral current I_N is the sum of the uncertainties on I₁, I₂, and I₃.
- For AmpFlex[®]/MiniFlex[®], I_{MAX} is limited to 60% I_{nom} at 50/60Hz, due to the higher sensitivity.
- ^① = indicative value.

Table 3

7.2.3.3 Measurement Specifications for DC

Quantity	Unit	Measurement range	Accuracy
Voltage (V)	V	10 to 1000V	± (0.2% Rdg + 0.2V)
Common to Ground/ Earth voltage (V _{PE})	V	2 to 600V	± (0.2% Rdg + 0.2V)
Current (I)	A	5 to 120% I _{nom}	± (0.2% Rdg + 0.02% I _{nom})
Common current (I)	A	5 to 120% I _{nom}	± (0.2% Rdg + 0.02% I _{nom})
Power (P)	W	V = 100 to 600V I = 5 to 120% I _{nom}	± (0.5% Rdg + 0.005% P _{nom}) ^①
Energy (E _p)	Wh	PF = 1 V = 100 to 600V I = 5 to 120% I _{nom}	± 1.5% Rdg ^①

In the preceding table:

- Rdg = Reading (displayed value).
- I_{nom} is the value of the measured current for a current probe output of 1V.
- P_{nom} is the Active Power for V = 600V and I = I_{nom}.
- The uncertainty for input current (I) is specified for an isolated input voltage of 1V = I_{nom}. The accuracy of the connected current probe should be added to this uncertainty to determine the total uncertainty.
- When there is no current probe, the uncertainty for neutral current I_N is the sum of the uncertainties on I₁, I₂, and I₃.

Table 4

7.2.3.4 Temperature

For V, U, I, P, Q, S, and energies:

- 300 ppm/°C, with 5% < I < 120% and PF=1
- 500 ppm/°C, with 10% < I < 120% and PF= 0.5 inductive

DC offset (V and I):

- 10 mV/°C typical
- 30 ppm x I_{nom}/°C typical

7.2.3.5 Common Mode Rejection

The common mode rejection ratio on neutral input is 140dB typical. For example, a voltage of 110V applied on the neutral input will add 11µV to AmpFlex®/MiniFlex® values. This is a 230mA error at 60Hz. A voltage of 110V applied on the neutral input will add 11µV to other current probes values, an additional error of 0.01% I_{nom}.

7.2.4 Current Probe Specifications

7.2.4.1 Current Probes with 1V Output

The following currents probe uncertainties do not include instrument uncertainties. The numbers listed below should be added to the uncertainties listed in Tables 2, 3, and 4 to calculate total uncertainty when using the instrument with a specific probe.

Model	I nominal of the range	Measurement current range	Accuracy	Maximum phase error at 50/60Hz	Typical phase error at 50/60Hz	Typical phase error at 400Hz
J93	3500A _{AC} 5000A _{DC}	50 to 250A	± (2% Rdg + 2.5A)	± 3°	-	-
		250 to 500A	± (1.5% Rdg + 2.5A)	± 2°	-	-
		500 to 3500A	± 1% Rdg	± 1.5°	-	-
		3500 to 5000A (DC only)	± 1% Rdg	-	-	-
SR193	1000A _{AC}	1 to 50A	± 1% Rdg	-	-	-
		50 to 100A	± 0.5% Rdg	± 1°	+0.25°	+0.1°
		100 to 1200A	± 0.3% Rdg	± 0.7°	+0.2°	@ 1000A
MN93	200A _{AC}	0.5 to 5A	± (3% Rdg + 1A)	-	-	-
		5 to 40A	± (2.5% Rdg + 1A)	± 5°	± 2°	-1.5° @ 40A
		40 to 100A	± (2% Rdg + 1A)	± 3°	± 1.2°	-0.8° @ 100A
		100 to 240A	± (1% Rdg + 1A)	± 2.5°	± 0.8°	-1° @ 200A
MN193	100A _{AC}	200mA to 5A	± (1% Rdg + 2mA)	± 4°	-	-
		5 to 120A	± 1% Rdg	± 2.5°	+ 0.75°	-0.5° @100A
	5A _{AC}	5 to 250mA	± (1.5% Rdg + 0.1mA)	-	-	-
		250mA to 6A	± 1% Rdg	± 5°	+ 1.7°	-0.5° @ 5A

5A Adapter	5A _{AC}	5 to 250mA	± (0.5% Rdg +2mA)	± 0.5°	-	-
		250mA to 6A	± (0.5% Rdg +1mA)	± 0.5°		
MR193	1000A _{AC/DC}	1 to 50A	± (1.5% Rdg + 1A)	-	-	- 4.5° @ 100A
		50 to 100A	± (1.5% Rdg + 1A)	± 2.5%	- 0.9°	
		100 to 800A	± 2.5% Rdg	± 2%	- 0.8°	
		800 to 1000A	± 4% Rdg		- 0.65°	
SL261 (with BNC adapter)	100A _{AC/DC}	5 to 40A	± (4% Rdg + 50mA)	± 1°	-	-
		40 to 100A	± 15% Rdg	± 1°	-	-
	10A _{AC/DC}	50mA to 10A	± (3% Rdg + 50mA)	± 1.5°	-	-

7.2.4.2 AmpFlex®/MiniFlex®

The following AmpFlex®/MiniFlex® accuracies include instrument accuracy for AC current values. To calculate accuracy for power/energies and other quantities, the following accuracies must be added to the accuracy for the instrument listed in Tables 2, 3, and 4.

Probe	I nominal of the range	Measurement current range	Accuracy at 50/60Hz	Accuracy at 400Hz	Maximum phase error at 50/60Hz	Typical phase error at 50/60Hz	Typical phase error at 400Hz
AmpFlex® A196	100A _{AC}	200mA to 5A	± (1.2% Rdg + 50mA)	± (2% Rdg + 0.1A)	-	-	-
		5 to 120A*			± 0.5°	0°	- 0.5°
	400A _{AC}	0.8 to 20A	± (1.2% Rdg + 0.2A)	± (2% Rdg + 0.4A)	-	-	-
		20 to 500A*			± 0.5°	0°	- 0.5°
	2000A _{AC}	4 to 100A*	± (1.2% Rdg + 1A)	± (2% Rdg ± 2A)	-	-	-
		100 to 2400A*			± 0.5°	0°	- 0.5°
	10000A _{AC}	20 to 500A	± (1.2% Rdg + 5A)	± (2% Rdg + 10A)	-	-	-
		500 to 12,000A*			± 0.5°	0°	- 0.5°
MiniFlex® MA193	100A _{AC}	200mA to 5A	± (1% Rdg + 50mA)	± (2% Rdg + 0.1A)	-	-	-
		5 to 120A*			± 0.5°	0°	- 0.5°
	400A _{AC}	0.8 to 20A	± (1% Rdg + 0.2A)	± (2% Rdg + 0.4A)	-	-	-
		20 to 500A*			± 0.5°	0°	- 0.5°
	2000A _{AC}	4 to 100A*	± (1% Rdg + 1A)	± (2% Rdg ± 2A)	-	-	-
		100 to 3000A*			± 0.5°	0°	- 0.5°

*The high range value is reduced by 50% when used at 400Hz.

7.3 Communication

Wi-Fi:

- 2.4GHz band IEEE 802.11 B/G/N radio
- TX power: +17dBm
- Rx sensitivity: -97dBm
- Security: WPA/WPA2
- Client (STA) mode support
- Access Point (AP) mode support for up to five clients

Network:

- RJ 45 connector with two integrated LEDs

Ethernet:

- 100 Base T

Bluetooth 2.1, Class 1

- Range: up to 100m (approximately 328') line-of-sight
- Default pairing code: 0000
- Nominal output power: +15dBm
- Nominal sensitivity: -82dBm
- Rate: 115Kbits/s

USB 2.0, Type B connector

7.4 Power Consumption

- Phase power via voltage measurement terminals, overvoltage Category 4 ground (earth) connection. Operating range: 100 to 1000V ($\pm 10\%$) @ 42.5 to 69Hz, 100 to 600V ($\pm 10\%$) @ 340 to 460Hz.
- Maximum power: 30VA, 140 to 1000V_{DC}
- Rechargeable NiMH battery, charge time approximately 5 hours, recharge temperature -20° to 55°C (-4° to 140°F), provides approximately one hour standalone operation without Bluetooth or Wi-Fi running. The battery is designed to last through at least 1000 recharge-discharge cycles over two years.
- Battery life: 1 hour without Bluetooth or Wi-Fi activated.
- External AC power input: 15V_{DC}.

Note that the internal clock is maintained for 20 days with the instrument powered down.

7.5 Physical

- Weight: approximately 4kg (8.8lb)
- Dimensions:
 - Depth: 245mm (9.65")
 - Width: 270mm (10.6"), 320mm (12.6") with leads connected
 - Height: 180mm (7.1")
- LCD: 107 by 84mm (4.2 by 3.3")
- Inputs: four current, five voltage
- Drop test: 20cm (approximately 8") in the most severe position without permanent mechanical damage and functional deterioration.
- Resistance to sunlight: Complies with the sunlight, UV, and water resistance requirements of UL 746C (f1).
- Degrees of protection provided by enclosure (IP code) according to IEC 60529:
 - IP67 when the cover is closed in any position and under operating conditions when terminals are mated or capped and the AmpFlex A196 connectors are screwed tight.
 - IP54 with caps when the cover is open in the horizontal position and under operating conditions.
 - IP40 without caps when the cover is open in the horizontal position and under operating conditions.

7.6 Environmental

Temperature and Relative Humidity (RH):

Reference Temperature: 68 to 78.8°F (20 to 26°C) from 45 to 75% RH

Operating Temperature: 32 to 108.5°F (0 to 42.5°C) from 10 to 85% RH
32 to 122°F (0 to 50°C) from 45 to 75% RH

Storage Temperature:

With batteries: -4 to 95°F (-20 to 35°C) from 0 to 95% RH
-4 to 122°F (-20 to 50°C) from 0 to 75% RH

Without batteries: N/A

Recharging Temperature: N/A

Altitude:

- Operating altitude: 0 to 2000m (0 to approximately 6600 ft)
- Storage altitude: 0 to 10000m (0 to approximately 6.2 miles)

7.7 Electrical Safety

The instrument complies with IEC 61010 for the followings: 1000V Category IV, pollution degree 4 in closed position (pollution degree 3 with cover open).

The current probes comply with IEC 61010-2-032.

The test leads and alligator clips comply with IEC 61010-031.

Note that the overall rated voltage and the measurement category of the instrument/probe system may be reduced depending on the current probe type or other accessories.

The instrument is protected internally by 1000V fuses against excessive current being drawn from the phase power supply due to faulty equipment or transient overvoltages. These fuses can only be replaced by authorized AEMC service personnel.

7.8 Electromagnetic Compatibility

- Immunity: Complies with IEC 61326-1. Immunity test requirements are for equipment intended for use in industrial locations.
- With MiniFlex® and AmpFlex® probes, the typical influence is 0.5% of full scale with a maximum of 5A.

7.9 Memory Card

The PEL 105 accepts FAT32 formatted SD and SDHC cards with up to 32GB capacity.

7.10 Current Probes and Sensors

The following tables provide specifications for the AmpFlex® Model A196-24-BK and all other supported probes and sensors. Note that only the A196-24-BK carries an IP67 rating.

7.10.1 AmpFlex® Model A196-24-BK

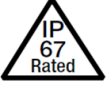
Flexible Current Probe AmpFlex® Model A196-24-BK		
 	Nominal range	100/400/2000/10000A _{AC}
	Measurement range	200mA to 12000A _{AC}
	Probe	Length: 610mm (24") Diameter (single loop): 190mm (7.64")
	Variation of the position of the conductor in the probe	≤ 2% any position and ≤ 4% near snap device
	Adjacent conductor carrying alternating current	≤ 1% any position and ≤ 2% near snap device
	Rating and Safety	1000V CAT IV, EN 61010-2-032, Pollution Degree 2

 **NOTE:** Current measurements <0.05% of the nominal range (100, 400, 2000 or 10000A) will be displayed as zero. Nominal ranges are reduced to 50/200/1000/5000A_{AC} at 400Hz.

7.10.2 MiniFlex® Model MA193

Flexible Current Probe MiniFlex® MA193		
	Nominal range	100/400/2000/10000A _{AC}
	Measurement range	200mA to 3000A _{AC}
	Dimensions	Length: 250mm (10") Diameter (single loop): 70mm (2.75")
	Variation of the position of the conductor in the probe	≤ 1.5% typical, 2.5% maximum
	Adjacent conductor carrying alternating current	≤ 1% for a conductor in contact with probe ≤ 2% near the snap device
	Rating and Safety	600V CAT IV, 1000V CAT III, EN 61010-2-032, Pollution Degree 2

 **NOTE:** Currents < 0.05% of the nominal range (100, 400, 2000 or 10,000A) will be displayed as zero. The nominal ranges are reduced to 50/200/1000/5000A_{AC} at 400Hz. MiniFlex® will operate when 10,000A is selected.

7.10.3 Model J93

Clamp-On AC/DC Current Probe Model J93		
	Nominal range	3500A _{AC} 5000A _{DC}
	Measurement range	50 to 3500A _{AC} 50 to 5000A _{DC}
	Maximum conductor size	72mm (2.84") diameter
	Variation of the position of the conductor in the probe	≤ 2%
	Adjacent conductor carrying alternating current	≤ 35dB typical, DC to 2kHz
	Rating and Safety	600V CAT IV, 1000V CAT III, IEC 61010-2-032, Pollution Degree 2
	Battery	9V alkaline (battery life 70 hours; typical consumption 11mA)

7.10.4 Model MR193-BK

Clamp-On AC/DC Current Probe Model MR193-BK		
	Nominal range	1000A _{AC} , 1400A _{DC} max
	Measurement range	1 to 1000A _{AC} , 1 to 1300A peak AC+DC
	Maximum conductor size	One 42mm (1.6") or two 25.4mm (0.98") cables Two bus bars 50 x 5mm (1.96 x 0.19")
	Variation of the position of the conductor in the probe	< 0.5% DC to 440Hz
	Adjacent conductor carrying alternating current	< 10mA/A at 50/60Hz
	Rating and Safety	300V CAT IV, 600V CAT III, EN 61010-2-032, Pollution Degree 2
	Battery	9V alkaline (battery life 70 hours; typical consumption 11mA)



NOTE: Currents < 1A_{AC/DC} will be displayed as zero.

7.10.5 Model MN93-BK

Clamp-On AC Current Probe Model MN93-BK		
	Nominal range	200A _{AC} for f ≤ 1kHz
	Measurement range	0.5 to 240A _{AC} max (I > 200A not permanent)
	Maximum conductor size	20mm (0.8") diameter
	Variation of the position of the conductor in the probe	< 0.5% at 50/60Hz
	Adjacent conductor carrying alternating current	≤ 15mA/A
	Rating and Safety	300V CAT IV, 600V CAT III, EN 61010-2-032, Pollution Degree 2

 **NOTE:** Currents < 0.1A will be displayed as zero.

7.10.6 Model SR193-BK

Clamp-On AC Current Probe Model SR193-BK		
	Nominal range	1000A _{AC} for f ≤ 1kHz
	Measurement range	1 to 1200A _{AC} max (I > 1000A not continuously)
	Maximum conductor size	52mm (2") diameter
	Variation of the position of the conductor in the probe	< 0.5% DC to 440Hz
	Adjacent conductor carrying alternating current	< 10mA/A at 50/60Hz
	Rating and Safety	600V CAT IV, 1000V CAT III, EN 61010-2-032, Pollution Degree 2

 **NOTE:** Currents < 0.5A will be displayed as zero.

7.10.7 Model MN193-BK

Clamp-On AC Current Probe Model MN193-BK		
	Nominal range	5A and 100A _{AC}
	Measurement range	5A: 0.005 to 6A _{AC} max 100A: 0.2 to 120A _{AC} max
	Maximum conductor size	20mm (0.8") diameter
	Variation of the position of the conductor in the probe	< 0.5% at 50/60Hz
	Adjacent conductor carrying alternating current	≤ 15mA/A at 50/60Hz
	Rating and Safety	300V CAT IV, 600V CAT III, EN 61010-2-032, Pollution Degree 2

NOTE: The 5A range of the MN193 is designed to work with secondary current transformers. Currents < 2.5mA x ratio on the 5A range and < 0.05A on the 100A range will be displayed as zero with this probe

7.10.8 Model SL261

This probe requires a BNC Adapter (Cat. #2140.40) for use with the PEL 105.

AC/DC Current Probe Model SL261		
	Nominal range	10A and 100A _{AC/DC}
	Measurement range	100mV/A: 50mA to 10A peak 10mV/A: 50mA to 100A peak
	Probe output signal	1000mV peak max
	Maximum conductor size	11.8mm (0.46") diameter
	Variation of the position of the conductor in the probe	< 0.5%
	Adjacent conductor carrying alternating current	-33dB typical, DC to 1kHz
	Battery	9V alkaline (battery life 55 hours; typical consumption 8.6mA)

7.11 Voltage Test Leads

The PEL 105 ships with five black test leads and alligator clips.

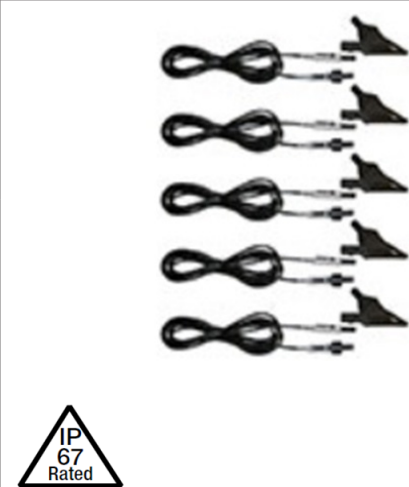
Voltage Test Leads and Alligator Clip		
	Length	3m (approximately 10')
	Rating	1000V CAT IV, 15A

Each lead includes a waterproof cap that screws into the instrument's threaded voltage terminals to ensure a water-tight (IP67) connection.

It may be possible to use other test leads with the instrument. However, only leads that screw into the voltage terminals can provide IP67 performance.

8. MAINTENANCE & TROUBLESHOOTING

There are several routine maintenance tasks you should perform periodically to ensure optimal operation of your instrument. In addition, the instrument may exhibit unexpected behavior that requires troubleshooting.

This chapter explains procedures you can perform to maintain the instrument and correct issues you may encounter.

8.1 Maintenance

Instrument maintenance tasks include:

- Erasing and upgrading the SD card
- Upgrading to the latest firmware revision
- Maintaining the batteries
- Cleaning the instrument

The following sections explain how to perform these tasks.

8.1.1 Erasing and Upgrading Memory

When the SD card  LED either (1) blinks alternately red and green, or (2) blinks green once per second, the SD card is either full or does not have enough remaining space to store the scheduled or in-progress recording session. In either case, you must erase the SD card to ensure sufficient storage capacity for future recordings. This is done via an option in the PEL Control Panel.

 **NOTE:** Erasing the SD card deletes all the records stored in memory. To save one or more recording sessions, you must download the session(s) to the computer.

You can remove the 8GB SD card that comes with the instrument and replace it with an SD card with up to 32GB storage. To do this:

1. Remove the existing SD card from the instrument by pressing down and then releasing it. The card will pop up, allowing you to pull it from the card slot.
2. Check the replacement card to ensure its write-protect sliding tab is in the “unlock” position (towards the metal contacts).
3. Insert the SD card into the slot, with the metal contacts facing towards the top of the card.
4. Press the SD card into the slot until it clicks in place.
5. If necessary, format the card by connecting the instrument to a computer running the PEL Control Panel and selecting the Format SD Card option.

When the new card is ready for storing recordings; the  LED glows steady green.

8.1.2 Upgrading Firmware

The PEL 105 firmware controls the features and functionality of the instrument. AEMC provides firmware updates free of charge to download through our DataView PEL Control Panel software.

 **NOTE:** Updating the firmware could reset the configuration and causes loss of stored data. As a precaution, save the stored data to a computer before updating the firmware.

To update the firmware, your computer must be running DataView with the PEL Control Panel (V2.2.9665 or later).

1. Power ON the instrument using external power, to ensure the instrument remains ON throughout the update procedure. Also ensure that the battery is at least 50% charged. **Do not perform an update with the instrument running on battery power, or with low battery charge. If the instrument turns OFF while firmware updating is in progress, it could become inoperative. External power with a sufficiently charged battery for backup helps minimize the risk of power interruptions during updating.**
2. Connect the PEL instrument to the computer using any connection other than IRD or Bluetooth.
3. Launch the DataView PEL Control Panel.
4. Ensure the instrument is listed in the PEL Network navigation tree. If it is, skip this step and go to step 5 below. If not, click **Instrument** in the menu bar and select **Add an Instrument**, then connect the instrument using the Add an Instrument Wizard. (Press F1 if you need assistance.)
5. Ensure the instrument is listed with a green check next to its name, indicating it is connected. If not, select the instrument and click **Instrument > Reconnect Instrument**. When the instrument is connected, select it.
6. By default, the PEL Control Panel automatically checks the connected instrument's firmware. If it is out of date, the Firmware Update dialog box appears, listing the instrument and any others running out-of-date firmware. Click **Update** (or **Select All** to update multiple instruments). This displays the Firmware Upgrade dialog box listing the latest firmware revisions for the PEL DSP and microprocessor; proceed as instructed in Step 7 below.

If the PEL Control Panel option "Check automatically for new firmware for connected instruments upon start of program" has been previously de-selected, the automatic firmware check does not occur. In this case, click **Instrument** in the menu bar. This includes the option **Firmware Upgrade**. If the selected instrument is running the latest firmware, this option is grayed out and inactive. If the instrument is not running the latest firmware, click Firmware Upgrade to display the Firmware Upgrade dialog box.

7. Click the **Start** button to begin the update. During this process, status bars display the progress of the DSP and microprocessor firmware updates. (Note that if only one of these requires updating, only its status bar appears.)
8. When the firmware update is complete, click the **Close** button to exit.

8.1.3 Battery Maintenance

The instrument is equipped with a NiMH battery, which provides approximately one hour of power. After prolonged storage, the battery may be completely discharged. If so, it must be completely charged. This requires approximately 5 hours. (See § 3.2.)

To make the best possible use of your battery and extend its effective service life:

- Only charge the battery at temperatures between -20° and 55°C (-4° and 140°F).
- Comply with the instrument usage and storage conditions defined in § 7.

Note that you cannot change the battery. This must be done at an authorized AEMC Service Center as part of the instrument's regular maintenance.

8.1.4 Cleaning the Instrument

The instrument should be cleaned periodically. This keeps the LCD clear and easily viewable, and also prevents dirt and grease buildup around the instrument's buttons and input terminals.





CAUTION! Risk of Electric Shock.
Before cleaning, disconnect all input(s) to prevent possible electric shock.

The body of the instrument should be cleaned with a damp and soapy cloth. Do not submerge the instrument in water. Do not use solvent.

8.2 Troubleshooting

This section describes how to correct several potential issues you may encounter. These include:

- The instrument does not turn ON when you press the Power  button.
- The instrument turns ON but does not function.
- You cannot configure settings through the instrument's front panel interface.
- You cannot start a recording session.
- Recording sessions end before the specified end date and time.
- You cannot connect to a computer.
- The instrument does not turn OFF when you press .

The following sections explain some of the possible causes for these issues and how you can address them. If you perform these troubleshooting actions but the issue still persists, or if you encounter a problem not covered in this section, please contact AEMC Technical Support.

8.2.1 Instrument Does Not Turn ON

The most common cause of failure to power ON is a completely discharged battery. Connect the instrument to an external power source, either external AC power or phase power. The instrument should immediately turn ON, and the Battery  LED should glow yellow and blink indicating the battery is recovering from a full discharge.

If the instrument does not turn ON when connected to external power, contact AEMC Technical Support.

8.2.2 Instrument Turns ON but Does Not Function

If the instrument has been stored in a cold and damp environment, condensation may form inside. This can short internal circuitry, preventing the instrument from operating normally. In this case, turn OFF the instrument and place it in a warm, dry environment for several hours. Then turn the instrument ON and try navigating through the screen interface to determine whether or not it has been restored to normal functionality.

8.2.3 Cannot Configure the Instrument

Several conditions may cause some or all configuration options to appear disabled, or function in unexpected ways. For example, when the instrument is locked or when it is recording data, none of the Configuration mode options is enabled. Instead, the word LOCK appears on the LCD when you enter Configuration mode.

The instrument is locked when it is being configured through the PEL Control Panel Configure Instrument dialog box. It can also be locked through a configuration option in the PEL Control Panel. When this option is enabled, the instrument remains locked even when disconnected from the computer.

To return local control to the instrument, ensure that the “Lock out the Control button on the instrument front panel” option in the PEL Control Panel is unchecked (see § 3.6). Then disconnect the instrument from the PEL Control Panel. If the instrument remains locked, check whether or not a recording is in progress. (The **REC** LED blinks twice every five seconds when a recording is active.) If so, either stop the recording or wait until it completes (see § 5.2).

If some configuration screens are active, while others are inactive (or don't appear at all), you may have the wrong hookup type selected. Hookup settings can affect which configuration screens are available. In this case, enter Information  mode and ensure the appropriate hookup type is selected.

8.2.4 Recording Sessions Do Not Start

If you attempt to start a recording either by pressing  or via the PEL Control Panel and the session does not start, check whether or not a recording is already in progress on the instrument (the **REC** LED blinks twice per second). To start a new recording, either wait for the in-progress recording to finish, or stop the recording.

Also check that the SD card is installed, operational, and has sufficient space to save the recording. If the  LED glows red, it is write-protected, not installed, or not recognized. If it blinks alternately red and green, it is full. If it blinks green once per second, it does not have enough space for the recording you are attempting to start.



Another condition that could prevent a recording session from starting is if the start and/or end times and dates are configured incorrectly, such as a stop date/time that has already passed. If the instrument has sufficient memory for the recording but it still will not start, check the recording's start and stop times/dates to ensure they are configured properly.

See § 5.2 for information about configuring a recording session.

8.2.5 Recording Sessions End Prematurely

If a recording session terminates before its scheduled stop time, a likely cause is that the SD card memory has become full. When this happens, the  LED glows red. Download any data you want to save, then erase the contents of the SD card through the PEL Control Panel (see § 8.1.1).

8.2.6 Cannot Connect to a Computer

If you cannot connect the computer via Wi-Fi or Bluetooth, ensure that the communication protocol through which you are attempting to connect is enabled. Check the appropriate LED:  for Wi-Fi,  for Bluetooth. If it is OFF (indicating the protocol is disabled) enable it as instructed in § 3.



If the  LED is blinking, the instrument is actively communicating with a computer. Only one Bluetooth connection at a time is supported; so ensure no other Bluetooth connection is active before attempting to connect to the instrument via Bluetooth.

If you are attempting to connect via USB or point-to-point Ethernet, ensure that the cable is securely connected to both the instrument and the computer. If the connections are secure, close the PEL Control Panel, disconnect the cable, wait a few seconds, then reconnect the cable. This resets the connection with the computer.

Also check the Communication settings in the PEL Control Panel, as explained in the PEL Control Panel Help system.

If you are attempting to connect via Bluetooth but you cannot connect the instrument via the PEL Control Panel – for example, the PEL 105 does not appear as available when you attempt to connect with it – the instrument may not be paired with the computer. Different computers and operating systems have different processes for pairing Bluetooth devices; consult the documentation that comes with your computer for instructions about how to do this.

8.2.7 Cannot Turn OFF the Instrument

The Power  button is disabled if a recording is active or pending. In addition, you cannot turn OFF the instrument if it is operating on external AC or phase power. Disconnect the power source, hold down  until all the instrument's LEDs light up, then release the button to turn OFF the instrument.

APPENDIX A: THEORY OF OPERATION

The instrument calculates measurements in accordance with IEC 61557-12 and IEC 61010-4-30. The following is a graphic representation of active and reactive power, in accordance with clauses 12 and 14 of IEC 60375.

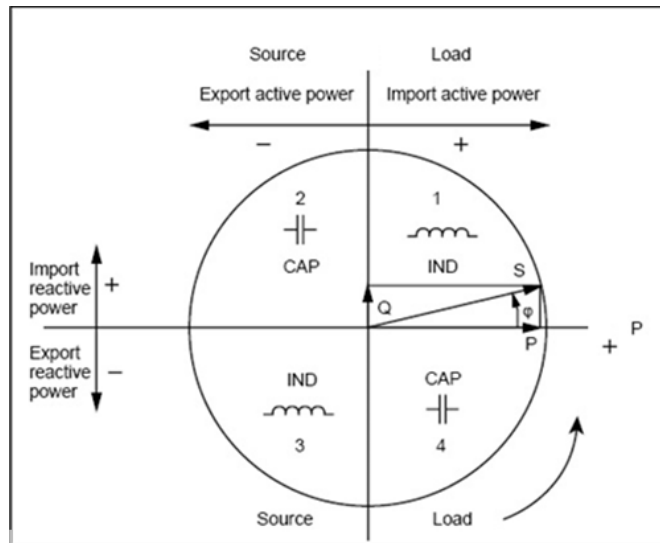

Figure 35

In this diagram:

- The current vector is fixed on the right-hand line.
- The voltage vector V varies direction according to the phase angle φ .
- The phase angle φ between voltage V and current I is considered mathematically positive (counter-clockwise).

A.1 Sampling

The sampling period is calculated every second, and varies according to the line frequency (50Hz, 60Hz, or 400Hz).

50Hz:

- 42.5 to 57.5Hz (50Hz \pm 15%), sampling period is locked to the main frequency. There are 128 samples available for each main cycle.
- Outside 42.5 to 57.5Hz, sampling period is 128 x 50Hz.

60Hz:

- 51 to 69Hz (60Hz \pm 15%), sampling period is locked to main frequency. 128 samples are available for each main cycle.
- Outside 51 to 69Hz, sampling period is 128 x 60Hz.

400Hz:

- 340 to 460Hz (400Hz \pm 15%), sampling period is locked to main frequency. For each main cycle, 16 samples are available.
- Outside 340 to 460Hz, sampling period is 16 x 400Hz.

Note that DC is not a frequency parameter for sampling. A pure DC measured signal is considered to be outside the frequency ranges. In this case sampling frequency is 6.4kHz (50/400Hz) or 7.68kHz (60Hz). By default, sampling frequency is locked on V_1 . If V_1 is missing, the instrument attempts to lock sampling frequency V_2 , then V_3 , I_1 , I_2 , and I_3 .

A.1.1 Locking the Sampling Frequency

By default, the sampling frequency is locked to V_1 . If V_1 is missing, the instrument attempts to lock to V_2 , then to V_3 , I_1 , I_2 , and I_3 .

A.1.2 AC/DC

The PEL 105 makes AC and DC measurements for AC and DC distribution networks. AC or DC is selected by the user.

The AC + DC values are available via the DataView PEL Control Panel.

A.1.3 Neutral Current Measurement

Depending on the distribution network, if there is no current sensor on the I_N terminal, the neutral current is calculated.

A.1.4 “200ms” Quantities

The instrument calculates the following quantities every 200ms based on measurements of 10 periods for 50Hz, 12 periods for 60Hz, and 80 periods for 400Hz. The “200ms” quantities are used for:

- Trends on the “1s” quantities
- Aggregation of the values for the “1s” quantities (see § A.1.6).

All “200ms” quantities can be recorded on the SD card during the recording session.

A.1.5 “1s” Quantities (one second)

The instrument calculates the following quantities every second based on measurements of 50 periods for 50Hz, 60 periods for 60Hz, and 400 periods for 400Hz. The “1s” quantities are used for:

- Real-time values
- Trends
- Aggregation of the values for the aggregated quantities (see § A.1.6).
- Determination of the values and maximum/minimum for the values of the aggregated trends

All “1s” quantities can be recorded on the SD card during the recording session.

A.1.6 Aggregation

An aggregated quantity is a value calculated for a defined period. Aggregation periods always start on rounded hours/minutes. The period is one of the following: 1, 2, 3, 4, 5, 6, 10, 12, 15, 20, 30, and 60 minutes.

All aggregated quantities are saved on the SD card during the recording session. They can be displayed in the PEL Control Panel.

A.1.7 Minimum and Maximum



The Min and Max are the minimum and maximum values observed during the aggregation period. They are recorded with their dates and times. The Max of some aggregated values are displayed directly on the instrument.

A.1.8 Energy Calculations

Energies are calculated every second. Total energy is the demand during the recording session. Partial energy can be determined for one of the following integration periods: 1h, 1 day, 1 week, or 1 month. The partial energy index is available only in real time. It is not recorded.

Note that total energies are available with the data of the recorded session.

A.2 Phase Sequence

Every second, the instrument determines the phase sequence. If the phase sequence does not meet the criteria listed in the tables below, the red Phase Sequence  LED blinks. In addition, the Phase Sequence  icon appears on the LCD.

To ensure proper phase sequence, the current phase sequence, voltage phase sequence, and current vs voltage phase sequence for that hookup must all be correct. Note that:

- Phase sequence for voltage channels is only displayed when voltages are displayed on the LCD.
- Phase sequence for current channels only is displayed when currents are displayed.
- Phase sequence for voltage and current channels is displayed when the other screens are displayed.
- Load or source is set by the PEL Control Panel.
- In some hookups (such as DC) the phase sequence does not always apply.

The following tables list the measurement ranges that ensure correct current phase sequence, voltage phase sequence, and current vs voltage phase sequence respectively.

A.2.1 Current Phase Sequence

Hookup	Current Phase Sequence	Range
1P-2W (1-Phase 2-Wire)	No	
1P -3W (1-Phase 3-Wire)	Yes	$\varphi (I_2, I_1) = 180^\circ \pm 30^\circ$
3P-3W Δ 2 (3-Phase 3-Wire Δ , 2 current probes)	Yes	$\varphi (I_1, I_3) = 120^\circ \pm 30^\circ$ No I_2 current probes
3P-3WO2 (3-Phase 3-Wire Open Δ , 2 current probes)		
3P-3WY2 (3-Phase 3-Wire Y, 2 current probes)		
3P-3W Δ 3 (3-Phase 3-Wire Δ , 3 current probes)	Yes	$[\varphi (I_1, I_3), \varphi (I_3, I_2), \varphi (I_2, I_1)] = 120^\circ \pm 30^\circ$
3P-3WO3 (3-Phase 3-Wire Open Δ , 3 current probes)		
3P-3WY3 (3-Phase 3-Wire Y, 3 current probes)		
3P-3W Δ b (3-Phase 3-Wire Δ balanced)	No	
3P-4WY (3-Phase 4-Wire Y)	Yes	$[\varphi (I_1, I_3), \varphi (I_3, I_2), \varphi (I_2, I_1)] = 120^\circ \pm 30^\circ$

3P-4WYb (3-Phase 4-Wire Y balanced)	No	
3P-4WY2 (3-Phase 4-Wire Y 2½)	Yes	$[\varphi (I_1, I_3), \varphi (I_3, I_2), \varphi (I_2, I_1)] = 120^\circ \pm 30^\circ$
3P-4WΔ (3-Phase 4-Wire Δ)	Yes	$[\varphi (I_1, I_3), \varphi (I_3, I_2), \varphi (I_2, I_1)] = 120^\circ \pm 30^\circ$
3P-4WOΔ (3-Phase 4-Wire Open Δ)		
DC-2W (DC 2-Wire)	No	
DC-3W (DC 3-Wire)	No	
DC-4W (DC 4-Wire)	No	

A.2.2 Voltage Phase Sequence

Hookup	Voltage Phase Sequence	Range
1P-2W (1-Phase 2-Wire)	No	
1P-3W (1-Phase 3-Wire)	Yes	$\varphi (V_2, V_1) = 180^\circ \pm 10^\circ$
3P-3WΔ2 (3-Phase 3-Wire Δ, 2 current probes)	Yes (on U)	$[\varphi (U_{12}, U_{31}), \varphi (U_{31}, U_{23}), \varphi (U_{23}, U_{12})] = 120^\circ \pm 10^\circ$
3P-3WO2 (3-Phase 3-Wire Open Δ, 2 current probes)		
3P-3WY2 (3-Phase 3-Wire Y, 2 current probes)		
3P-3WΔ3 (3-Phase 3-Wire Δ, 3 current probes)		
3P-3WO3 (3-Phase 3-Wire Open Δ, 3 current probes)		
3P-3WY3 (3-Phase 3-Wire Y, 3 current probes)		
3P-3WΔb (3-Phase 3-Wire Δ balanced)	No	
3P-4WY (3-Phase 4-Wire Y)	Yes (on V)	$[\varphi (V_1, V_3), \varphi (V_3, V_2), \varphi (V_2, V_1)] = 120^\circ \pm 10^\circ$
3P-4WYb (3-Phase 4-Wire Y balanced)	No	
3P-4WY2 (3-Phase 4-Wire Y 2½)	Yes (on V)	$\varphi (V_1, V_3) = 120^\circ \pm 10^\circ$ No V_2
3P-4WΔ (3-Phase 4-Wire Δ)	Yes (on U)	$\varphi (V_1, V_3) = 180^\circ \pm 10^\circ$ $[\varphi (U_{12}, U_{31}), \varphi (U_{31}, U_{23}), \varphi (U_{23}, U_{12})] = 120^\circ \pm 10^\circ$
3P-4WOΔ (3-Phase 4-Wire Open Δ)		

DC-2W (DC 2-Wire)	No	
DC-3W (DC 3-Wire)	No	
DC-4W (DC 4-Wire)	No	

A.2.3 Current vs Voltage Phase Sequence

Hookup	Current vs Voltage Phase Sequence	Range
1P-2W (1-Phase 2-Wire)	Yes	$\varphi (I_1, V_1) = 0^\circ \pm 60^\circ$ for load $\varphi (I_1, V_1) = 180^\circ \pm 60^\circ$ for source
1P -3W (1-Phase 3-Wire)	Yes	$[\varphi (I_1, V_1), \varphi (I_2, V_2)] = 0^\circ \pm 60^\circ$ for load $[\varphi (I_1, V_1), \varphi (I_2, V_2)] = 180^\circ \pm 60^\circ$ for source
3P-3W Δ 2 (3-Phase 3-Wire Δ , 2 current probes)	Yes	$[\varphi (I_1, U_{12}), \varphi (I_3, U_{31})] = 30^\circ \pm 60^\circ$ for load $[\varphi (I_1, U_{12}), \varphi (I_3, U_{31})] = 210^\circ \pm 60^\circ$ for source No I_2 current probes
3P-3WO2 (3-Phase 3-Wire Open Δ , 2 current probes)		
3P-3WY2 (3-Phase 3-Wire Y, 2 current probes)		
3P-3W Δ 3 (3-Phase 3-Wire Δ , 3 current probes)	Yes	$[\varphi (I_1, U_{12}), \varphi (I_2, U_{23}), \varphi (I_3, U_{31})] = 30^\circ \pm 60^\circ$ for load $[\varphi (I_1, U_{12}), \varphi (I_2, U_{23}), \varphi (I_3, U_{31})] = 210^\circ \pm 60^\circ$ for source
3P-3WO3 (3-Phase 3-Wire Open Δ , 3 current probes)		
3P-3WY3 (3-Phase 3-Wire Y, 3 current probes)		
3P-3W Δ b (3-Phase 3-Wire Δ balanced)	Yes	$\varphi (I_3, U_{12}) = 90^\circ \pm 60^\circ$ for load $\varphi (I_3, U_{12}) = 270^\circ \pm 60^\circ$ for source
3P-4WY (3-Phase 4-Wire Y)	Yes	$[\varphi (I_1, V_1), \varphi (I_2, V_2), \varphi (I_3, V_3)] = 0^\circ \pm 60^\circ$ for load $[\varphi (I_1, V_1), \varphi (I_2, V_2), \varphi (I_3, V_3)] = 180^\circ \pm 60^\circ$ for source
3P-4WYb (3-Phase 4-Wire Y balanced)	Yes	$\varphi (I_1, V_1) = 0^\circ \pm 60^\circ$ for load $\varphi (I_1, V_1) = 180^\circ \pm 60^\circ$ for source
3P-4WY2 (3-Phase 4-Wire Y 2½)	Yes	$[\varphi (I_1, V_1), \varphi (I_3, V_3)] = 0^\circ \pm 60^\circ$ for load $[\varphi (I_1, V_1), \varphi (I_3, V_3)] = 180^\circ \pm 60^\circ$ for source No V_2
3P-4W Δ (3-Phase 4-Wire Δ)	Yes	$[\varphi (I_1, U_{12}), \varphi (I_2, U_{23}), \varphi (I_3, U_{31})] = 30^\circ \pm 60^\circ$ for load $[\varphi (I_1, U_{12}), \varphi (I_2, U_{23}), \varphi (I_3, U_{31})] = 210^\circ \pm 60^\circ$ for source
3P-4WO Δ (3-Phase 4-Wire Open Δ)		
DC-2W (DC 2-Wire)	No	
DC-3W (DC 3-Wire)	No	
DC-4W (DC 4-Wire)	No	

APPENDIX B: MEASUREMENT QUANTITIES

The following table lists all quantities measured or calculated by the instrument, organized by hookup type. Circles indicate that the quantity is measured for the hookup.

For example, the first quantity listed in the table is V_1 (line 1 voltage). Circles in the 1P-2W and 1P-3W columns indicate V_1 is measured for single-phase 2-wire and single-phase 3-wire hookups. The absence of a circle in the 3P-3W Δ b column indicates V_1 is not measured for 3-phase 3-wire Δ balanced hookups.

Quantities		1P-2W	1P-3W	3P-3W Δ 2 3P-3WO2 3P-3WY2	3P-3W Δ 3 3P-3WO3 3P-3WY3	3P-3W Δ b	3P-4WY	3P-4WYb	3P-4WY2	3P-4W Δ 3P-4WO Δ	DC-2W	DC-3W	DC-4W
V_1	AC RMS	●	●				●	●	●	●			
V_2	AC RMS		●				●	● = V_1	● ⁽¹⁰⁾	●			
V_3	AC RMS						●	● = V_1	●	●			
V_N	AC RMS	●	●				●	●	●	●			
V_1	DC										●	●	●
V_2	DC											●	●
V_3	DC												●
V_N	DC	●	●				●	●	●	●	●	●	●
V_1	AC+DC RMS	●	●				●	●	●	●			
V_2	AC+DC RMS		●				●	● ⁽¹⁾	● ⁽¹⁰⁾	●			
V_3	AC+DC RMS						●	● ⁽¹⁾	●	●			
V_N	AC+DC RMS	●	●				●	●	●	●			
U_{12}	AC RMS		●	●	●	●	●	● ⁽¹⁾	● ⁽¹⁰⁾	●			
U_{23}	AC RMS			●	●	● ⁽¹⁾	●	● ⁽¹⁾	● ⁽¹⁰⁾	●			
U_{31}	AC RMS			●	●	● ⁽¹⁾	●	● ⁽¹⁾	●	●			
I_1	AC RMS	●	●	●	●	● ⁽¹⁾	●	●	●	●			
I_2	AC RMS		●	● ⁽²⁾	●	● ⁽¹⁾	●	● ⁽¹⁾	●	●			

Quantities		1P-2W	1P-3W	3P-3W Δ 2 3P-3WO2 3P-3WY2	3P-3W Δ 3 3P-3WO3 3P-3WY3	3P-3W Δ b	3P-4WY	3P-4WYb	3P-4WY2	3P-4W Δ 3P-4WO Δ	DC-2W	DC-3W	DC-4W
I_3	AC RMS			●	●	●	●	● ⁽¹⁾	●	●			
I_N	AC RMS		●				● ⁽¹¹⁾	●	●	●			
I_1	AC+DC RMS	●	●	●	●	● ⁽¹⁾	●	●	●	●			
I_2	AC+DC RMS		●	● ⁽²⁾	●	● ⁽¹⁾	●	● ⁽¹⁾	●	●			
I_3	AC+DC RMS			●	●	●	●	● ⁽¹⁾	●	●			
I_N	AC+DC RMS		●				●	●	●	●			
I_1	DC										●	●	●
I_2	DC											●	●
I_3	DC												●
I_N	DC											●	●
V_{1CF}		●	●				●	●	●	●			
V_{2CF}			●				●	● ⁽¹⁾	● ⁽¹⁰⁾	●			
V_{3CF}							●	● ⁽¹⁾	●	●			
I_{1CF}		●	●	●	●	●	●	●	●	●			
I_{2CF}			●	● ⁽²⁾	●	● ⁽¹⁾	●	● ⁽¹⁾	●	●			
I_{3CF}				●	●	● ⁽¹⁾	●	● ⁽¹⁾	●	●			
V_+				●	●	●	●	●	● ⁽¹⁰⁾				
V_-				●	●	● ⁽⁴⁾	●	● ⁽⁴⁾	● ⁽¹⁰⁾				
V_0				●	●	● ⁽⁴⁾	●	● ⁽⁴⁾	● ⁽¹⁰⁾				
I_+				●	●	●	●	●	●				
I_-				●	●	● ⁽⁴⁾	●	● ⁽⁴⁾	●				
I_0				●	●	● ⁽⁴⁾	●	● ⁽⁴⁾	●				

Quantities		1P-2W	1P-3W	3P-3W Δ 2 3P-3WO2 3P-3WY2	3P-3W Δ 3 3P-3WO3 3P-3WY3	3P-3W Δ b	3P-4WY	3P-4WYb	3P-4WY2	3P-4W Δ 3P-4WO Δ	DC-2W	DC-3W	DC-4W
U ₀				●	●	● ⁽⁴⁾	●	● ⁽⁴⁾	● ⁽⁴⁾	● ⁽³⁾			
U ₂				●	●	● ⁽⁴⁾	●	● ⁽⁴⁾	● ⁽⁴⁾	● ⁽³⁾			
I ₀				●	●	● ⁽⁴⁾	●	● ⁽⁴⁾	●	● ⁽³⁾			
I ₂				●	●	● ⁽⁴⁾	●	● ⁽⁴⁾	●	● ⁽³⁾			
F		●	●	●	●	●	●	●	●	●			
P ₁	AC	●	●				●	●	●	●			
P ₂	AC		●				●	● ⁽¹⁾	● ⁽¹⁰⁾	●			
P ₃	AC						●	● ⁽¹⁾	●	●			
P _T	AC	● ⁽⁷⁾	●	●	●	●	●	● ⁽¹⁾	●	●			
P ₁	DC										●	●	●
P ₂	DC											●	●
P ₃	DC												●
P _T	DC										● ⁽⁷⁾	●	●
P ₁	AC+DC	●	●				●	●	●	●			
P ₂	AC+DC		●				●	● ⁽¹⁾	● ⁽¹⁰⁾	●			
P ₃	AC+DC						●	● ⁽¹⁾	●	●			
P _T	AC+DC	● ⁽⁷⁾	●	●	●	●	●	● ⁽¹⁾	●	●			
P _{F1}		●	●				●	●	●	●			
P _{F2}			●				●	● ⁽¹⁾	● ⁽¹⁰⁾	●			
P _{F3}							●	● ⁽¹⁾	●	●			
P _{FT}		● ⁽⁷⁾	●	●	●	●	●	● ⁽¹⁾	●	●			
P ₊				●	●	●	●	● ⁽¹⁾	●				

Quantities		1P-2W	1P-3W	3P-3W Δ 2 3P-3WO2 3P-3WY2	3P-3W Δ 3 3P-3WO3 3P-3WY3	3P-3W Δ b	3P-4WY	3P-4WYb	3P-4WY2	3P-4W Δ 3P-4WO Δ	DC-2W	DC-3W	DC-4W
P _U				●	●	● ⁽⁴⁾	●	● ⁽⁴⁾	●				
P _H		●	●	●	●	●	●	●	●				
Q ₁		●	●				●	●	●	●			
Q ₂			●				●	● ⁽¹⁾	● ⁽¹⁰⁾	●			
Q ₃							●	● ⁽¹⁾	●	●			
Q _T		● ⁽⁷⁾	●	●	●	●	●	● ⁽¹⁾	●	●			
S ₁	AC	●	●				●	●	●	●			
S ₂	AC		●				●	● ⁽¹⁾	● ⁽¹⁰⁾	●			
S ₃	AC						●	● ⁽¹⁾	●	●			
S _T	AC	● ⁽⁷⁾	●	●	●	●	●	● ⁽¹⁾	●	●			
S ₁	AC+DC	●	●				●	●	●	●			
S ₂	AC+DC		●				●	● ⁽¹⁾	● ⁽¹⁰⁾	●			
S ₃	AC+DC						●	● ⁽¹⁾	●	●			
S _T	AC+DC	● ⁽⁷⁾	●	●	●	●	●	● ⁽¹⁾	●	●			
S _{F1}		●	●				●	●	●	●			
S _{F2}			●				●	● ⁽¹⁾	● ⁽¹⁰⁾	●			
S _{F3}							●	● ⁽¹⁾	●	●			
S _{FT}		● ⁽⁷⁾	●	●	●	●	●	● ⁽¹⁾	●	●			
N ₁	AC	●	●				●	●	●	●			
N ₂	AC		●				●	● ⁽¹⁾	● ⁽¹⁰⁾	●			
N ₃	AC						●	● ⁽¹⁾	●	●			
N _T	AC	● ⁽⁷⁾	●	●	●	●	●	● ⁽¹⁾	●	●			

Quantities		1P-2W	1P-3W	3P-3W Δ 2 3P-3WO2 3P-3WY2	3P-3W Δ 3 3P-3WO3 3P-3WY3	3P-3W Δ b	3P-4WY	3P-4WYb	3P-4WY2	3P-4W Δ 3P-4WO Δ	DC-2W	DC-3W	DC-4W
N ₁	AC+DC	●	●				●	●	●	●			
N ₂	AC+DC		●				●	● ⁽¹⁾	● ⁽¹⁰⁾	●			
N ₃	AC+DC						●	● ⁽¹⁾	●	●			
N _T	AC+DC	● ⁽⁷⁾	●	●	●	●	●	● ⁽¹⁾	●	●			
D ₁	AC	●	●				●	●	●	●			
D ₂	AC		●				●	● ⁽¹⁾	● ⁽¹⁰⁾	●			
D ₃	AC						●	● ⁽¹⁾	●	●			
D _T	AC	● ⁽⁷⁾	●	●	●	●	●	● ⁽¹⁾	●	●			
D ₁	AC+DC	●	●				●	●	●	●			
D ₂	AC+DC		●				●	● ⁽¹⁾	● ⁽¹⁰⁾	●			
D ₃	AC+DC						●	● ⁽¹⁾	●	●			
D _T	AC+DC	● ⁽⁷⁾	●	●	●	●	●	● ⁽¹⁾	●	●			
PF ₁		●	●				●	●	●	●			
PF ₂			●				●	● ⁽¹⁾	● ⁽¹⁰⁾	●			
PF ₃							●	● ⁽¹⁾	●	●			
PF _T		● ⁽⁷⁾	●	●	●	●	●	● ⁽¹⁾	●	●			
Cos ρ_1		●	●				●	●	●	●			
Cos ρ_2			●				●	● ⁽¹⁾	● ⁽¹⁰⁾	●			
Cos ρ_3							●	● ⁽¹⁾	●	●			
Cos ρ_T		● ⁽⁷⁾	●	●	●	●	●	● ⁽¹⁾	●	●			
TAN ϕ		●	●	●	●	● ⁽³⁾	●	●	● ⁽¹⁰⁾	●			

Quantities		1P-2W	1P-3W	3P-3W Δ 2 3P-3WO2 3P-3WY2	3P-3W Δ 3 3P-3WO3 3P-3WY3	3P-3W Δ b	3P-4WY	3P-4WYb	3P-4WY2	3P-4W Δ 3P-4WO Δ	DC-2W	DC-3W	DC-4W
V ₁ -Hi	i=1 to 50 ⁽⁶⁾ %f	●	●				●	●	●	●			
V ₂ -Hi			●				●	● ⁽¹⁾	● ⁽¹⁰⁾	●			
V ₃ -Hi							●	● ⁽¹⁾	●	●			
U ₁₂ -Hi	i=1 to 50 ⁽⁶⁾ %f		●	●	●	●	●	● ⁽¹⁾	● ⁽¹⁰⁾	●			
U ₂₃ -Hi				●	●	● ⁽¹⁾	●	● ⁽¹⁾	● ⁽¹⁰⁾	●			
U ₃₁ -Hi				●	●	● ⁽¹⁾	●	● ⁽¹⁾	●	●			
I ₁ -Hi	i=1 to 50 ⁽⁶⁾ %f	●	●	●	●	● ⁽¹⁾	●	●	●	●			
I ₂ -Hi			●	● ⁽²⁾	●	● ⁽¹⁾	●	● ⁽¹⁾	●	●			
I ₃ -Hi				●	●	●	●	● ⁽¹⁾	●	●			
I _n -Hi			● ⁽²⁾					● ⁽¹¹⁾	● ⁽⁴⁾	● ⁽²⁾	● ⁽²⁾		
V ₁ -Hi	i=1 to 50 ⁽⁶⁾ RMS	●	●				●	●	●	●			
V ₂ -Hi			●				●	● ⁽¹⁾	● ⁽¹⁰⁾	●			
V ₃ -Hi							●	● ⁽¹⁾	●	●			
U ₁₂ -Hi	i=1 to 50 ⁽⁶⁾ RMS		●	●	●	●	●	● ⁽¹⁾	● ⁽¹⁰⁾	●			
U ₂₃ -Hi				●	●	● ⁽¹⁾	●	● ⁽¹⁾	● ⁽¹⁰⁾	●			
U ₃₁ -Hi				●	●	● ⁽¹⁾	●	● ⁽¹⁾	●	●			
I ₁ -Hi	i=1 to 50 ⁽⁶⁾ RMS	●	●	●	●	● ⁽¹⁾	●	●	●	●			
I ₂ -Hi			●	● ⁽²⁾	●	● ⁽¹⁾	●	● ⁽¹⁾	●	●			
I ₃ -Hi				●	●	●	●	● ⁽¹⁾	●	●			
I _n -Hi			● ⁽²⁾					● ⁽¹¹⁾	● ⁽⁴⁾	● ⁽²⁾	● ⁽²⁾		
V ₁ -THD	%f	●	●				●	●	●	●			
V ₂ -THD	%f		●				●	● ⁽¹⁾	● ⁽¹⁰⁾	●			

Quantities		1P-2W	1P-3W	3P-3W Δ 2 3P-3WO2 3P-3WY2	3P-3W Δ 3 3P-3WO3 3P-3WY3	3P-3W Δ b	3P-4WY	3P-4WYb	3P-4WY2	3P-4W Δ 3P-4WO Δ	DC-2W	DC-3W	DC-4W
V ₃ -THD	%f						●	● ⁽¹⁾	●	●			
U ₁₂ -THD	%f		●	●	●	●	●	● ⁽¹⁾	● ⁽¹⁰⁾	●			
U ₂₃ -THD	%f			●	●	● ⁽¹⁾	●	● ⁽¹⁾	● ⁽¹⁰⁾	●			
U ₃₁ -THD	%f			●	●	● ⁽¹⁾	●	● ⁽¹⁾	●	●			
I ₁ -THD	%f	●	●	●	●	● ⁽¹⁾	●	●	●	●			
I ₂ -THD	%f		●	● ⁽²⁾	●	● ⁽¹⁾	●	● ⁽¹⁾	●	●			
I ₃ -THD	%f			●	●	●	●	● ⁽¹⁾	●	●			
I _N -THD	%f		● ⁽²⁾				● ⁽¹¹⁾	● ⁽⁴⁾	● ⁽²⁾	● ⁽²⁾			
Phase sequence	I		●	●	●		●		●	●			
	V		●	●	●		●		●	●			
	I, V	●	●	●	●	●	●	●	●	●			
$\varphi(V_2, V_1)$		●				●	● ⁽⁹⁾						
$\varphi(V_3, V_2)$						●	● ⁽⁹⁾						
$\varphi(V_1, V_3)$						●	● ⁽⁹⁾	●	●				
$\varphi(U_{23}, U_{12})$				●	●	● ⁽⁹⁾	●	● ⁽⁹⁾		●			
$\varphi(U_{12}, U_{31})$				●	●	● ⁽⁹⁾	●	● ⁽⁹⁾		●			
$\varphi(U_{31}, U_{23})$				●	●	● ⁽⁹⁾	●	● ⁽⁹⁾		●			
$\varphi(I_2, I_1)$			●		●	● ⁽⁹⁾	●	● ⁽⁹⁾	●	●			
$\varphi(I_3, I_2)$					●	● ⁽⁹⁾	●	● ⁽⁹⁾	●	●			
$\varphi(I_1, I_3)$				●	●	● ⁽⁹⁾	●	● ⁽⁹⁾	●	●			
$\varphi(I_1, V_1)$		●	●			● ⁽⁸⁾	●	●	●	●			

Quantities		1P-2W	1P-3W	3P-3W Δ 2 3P-3WO2 3P-3WY2	3P-3W Δ 3 3P-3WO3 3P-3WY3	3P-3W Δ b	3P-4WY	3P-4WYb	3P-4WY2	3P-4W Δ 3P-4WO Δ	DC-2W	DC-3W	DC-4W
$\varphi(I_2, V_2)$			●				●	● = $\varphi(I_1, V_1)$					
$\varphi(I_3, V_3)$							●	● = $\varphi(I_1, V_1)$	●	●			
E _{PT}	Source AC	●	●	●	●	●	●	●	●	●	● ⁽⁵⁾	● ⁽⁵⁾	● ⁽⁵⁾
E _{PT}	Load AC	●	●	●	●	●	●	●	●	●	● ⁽⁵⁾	● ⁽⁵⁾	● ⁽⁵⁾
E _{OT}	Quad 1	●	●	●	●	●	●	●	●	●	● ⁽⁵⁾	● ⁽⁵⁾	● ⁽⁵⁾
E _{OT}	Quad 2	●	●	●	●	●	●	●	●	●	● ⁽⁵⁾	● ⁽⁵⁾	● ⁽⁵⁾
E _{OT}	Quad 3	●	●	●	●	●	●	●	●	●	● ⁽⁵⁾	● ⁽⁵⁾	● ⁽⁵⁾
E _{OT}	Quad 4	●	●	●	●	●	●	●	●	●	● ⁽⁵⁾	● ⁽⁵⁾	● ⁽⁵⁾
E _{ST}	Source	●	●	●	●	●	●	●	●	●	● ⁽⁵⁾	● ⁽⁵⁾	● ⁽⁵⁾
E _{ST}	Load	●	●	●	●	●	●	●	●	●	● ⁽⁵⁾	● ⁽⁵⁾	● ⁽⁵⁾
E _{PT}	Source DC	● ⁽⁵⁾	● ⁽⁵⁾	● ⁽⁵⁾	● ⁽⁵⁾	● ⁽⁵⁾	● ⁽⁵⁾	● ⁽⁵⁾	● ⁽⁵⁾	● ⁽⁵⁾	●	●	●
E _{PT}	Load DC	● ⁽⁵⁾	● ⁽⁵⁾	● ⁽⁵⁾	● ⁽⁵⁾	● ⁽⁵⁾	● ⁽⁵⁾	● ⁽⁵⁾	● ⁽⁵⁾	● ⁽⁵⁾	●	●	●

- Available
- (1) Extrapolated
- (2) Calculated
- (3) Not a real quantity
- (4) Always = 0
- (5) AC+DC when selected
- (6) Rank 7 for 400Hz

- (7) $P_1 = P_T, Q_1 = Q_T, N_1 = N_T, D_1 = D_T, S_1 = S_T, PF_1 = PF_T, \cos \varphi_1 = \cos \varphi_T, PF_1 = PF_T$
- (8) $\varphi(I_3, U_{12})$
- (9) Always = 120°
- (10) Interpolated
- (11) Calculated or measured if a current sensor is connected

APPENDIX C: POLE MOUNTING

Accessory brackets (Cat. #2137.81) enable you to mount the Model PEL 105 on a utility pole or similar structure.



Figure 36

To mount the instrument on a pole, turn it OFF and detach all leads and other connections. Then do the following:

1. Slide the brackets onto the bottom of the instrument.

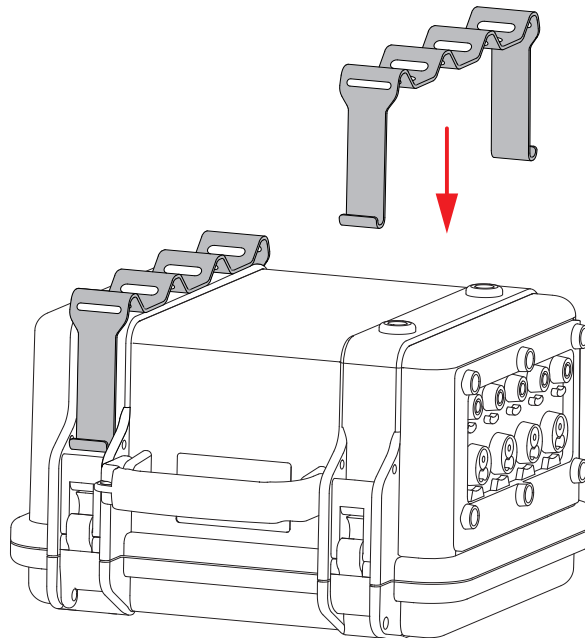

Figure 37

2. Attach the bracket by inserting the four connecting pins into the holes in the instrument case.
3. Insert the four clips into the holes in the pins.

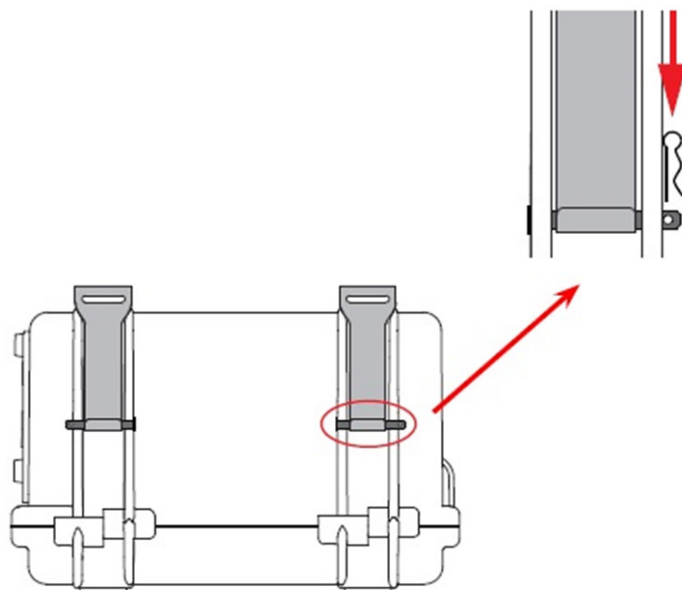

Figure 38

4. Run two straps (not included) through the slots in the brackets. These slots are 25.4 x 4mm (1 x 0.157”).
5. Position the instrument on the pole, and attach it by fastening the straps.

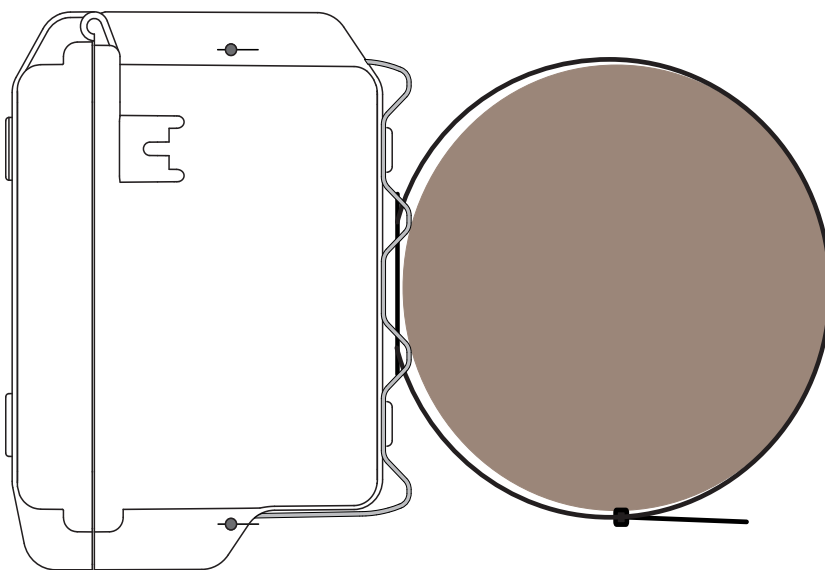

Figure 39

GLOSSARY

Symbol/Term	Definition
φ	Phase angle. For example: $\varphi (I_1, I_2)$ is the phase angle between line 1 current and line 2 current. $\varphi (I_1, V_1)$ is the phase angle between line 1 current and line 1 voltage. $\varphi (U_{31}, U_{23})$ is the phase angle between phase 3-to-phase 1 voltage and phase 2-to-phase 3 voltage. $\varphi (V_1, V_2)$ is the phase angle between line 1 voltage and line 2 voltage.
A (Amps or Amperes)	Unit of measure for current. For example: A_{AC} is AC current. A_{DC} is DC current.
AC	Alternating current.
CF	Crest factor in current or voltage. This is the ratio of the Peak value of a signal to the RMS value (Peak/RMS).
$\cos \varphi$	Cosine of the phase shift of the fundamental voltage with respect to the fundamental current.
DC	Direct current.
E	Energy. For example: E_p is active energy. E_{p+} is consumed active energy. E_{p-} is generated active energy. E_a is reactive energy. E_s is apparent energy. E_{s+} is consumed apparent energy. E_{s-} is generated apparent energy.
F (Frequency)	Number of AC voltage or current cycles in one second, measured in Hertz (Hz).
Fundamental frequency	Primary frequency of the AC electrical network, typically 50Hz, 60Hz, or 400Hz.
Harmonics	Voltages and currents at frequencies that are multiples of the fundamental frequency. Harmonics distort the fundamental waveform and can affect the performance of electrical equipment and components.
Harmonic Order	Ratio of the frequency of the harmonic to the fundamental frequency; expressed as a whole number. For example, in a 60Hz system the 1st harmonic order = 60Hz, 3rd order = 180Hz, 5th order = 300Hz, and so on.
Hz (Hertz)	Unit of measurement for frequency, representing the number of cycles per second. For example, 60Hz equals 60 cycles per second.

Symbol/Term	Definition
I	Current. For example: I_1 is line 1 current. I_N is neutral current. I-CF crest factor of current (Peak/RMS). I-THD total harmonic distortion of current.
L	Line (phase). For example, L_1 is line 1 or phase 1.
MAX	Maximum value. Typically, this represents the maximum measurement during a specified time interval.
MIN	Minimum value.
Nominal voltage	Reference voltage of the electrical network.
P	Active power (W).
PF (Power Factor)	Ratio of active power to apparent power (W/VA).
Phase	Temporal relationship between current and voltage in AC circuits.
Q	Reactive power (var).
RMS (Root Mean Square)	Square root of the mean of the squares of the instantaneous current or voltage values during a specified interval.
S	Apparent power (VA).
TAN	Tangent of the phase angle between current and voltage.
Tan ϕ	Ratio between reactive power and active power (var/W).
THD (Total Harmonic Distortion)	Ratio between the sum of all harmonic RMS values and the electrical network's fundamental RMS, expressed as a percentage of the fundamental. For example: THD_I is total harmonic distortion for current. THD_I ₁ is total harmonic distortion for phase 1 current. THD_V is total harmonic distortion for voltage. THD_V ₁ is total harmonic distortion for phase 1 voltage. THD_U ₁₂ is total harmonic distortion for voltage between phase 1 and phase 2.
U	Phase-to-phase voltage. For example: U_{12} is phase 1 to phase 2 voltage. U_{1-H_n} is phase-to-phase voltage value or percentage for harmonic rank n. U_{12-THD} is total phase 1-to-phase 2 voltage harmonic distortion. U-CF is phase-to-phase voltage crest factor. U_h is phase-to-phase voltage harmonic.
V	Voltage. For example: V_1 is line 1 voltage. V_{AC} is AC voltage. V-CF is voltage crest (peak) factor. V_{DC} is DC voltage. V_N is neutral voltage. V-THD is total harmonic distortion of phase-to-neutral voltage. V_{UNB} is phase-to-neutral voltage unbalance, expressed in percent.
VA	Apparent power, expressed in volt-amperes.
var	Reactive power, expressed in volt-amperes.

Symbol/Term	Definition
varh	Reactive energy, expressed in volt-amperes.
Vh	Phase-to-neutral voltage harmonic.
VNE	Voltage at neutral (V_N)
W (Watt)	Unit of measure for power.

REPAIR AND CALIBRATION

To ensure that your instrument meets factory specifications, we recommend that it be scheduled to be sent back to our factory Service Center at one-year intervals for recalibration, or as required by other standards or internal procedures.

For instrument repair and calibration:

You must contact our Service Center for a Customer Service Authorization Number (CSA#). This will ensure that when your instrument arrives, it will be tracked and processed promptly. Please write the CSA# on the outside of the shipping container. If the instrument is returned for calibration, we need to know if you want a standard calibration, or a calibration traceable to N.I.S.T. (Includes calibration certificate plus recorded calibration data).

Ship To: Chauvin Arnoux®, Inc. d.b.a. AEMC® Instruments
15 Faraday Drive • Dover, NH 03820 USA
Phone: (800) 945-2362 (Ext. 360)
(603) 749-6434 (Ext. 360)
Fax: (603) 742-2346 or (603) 749-6309
E-mail: repair@aemc.com

(Or contact your authorized distributor.)

Costs for repair, standard calibration, and calibration traceable to N.I.S.T. are available.

NOTE: You must obtain a CSA# before returning any instrument.

TECHNICAL AND SALES ASSISTANCE

If you are experiencing any technical problems, or require any assistance with the proper operation or application of your instrument, please call, fax, or e-mail our technical support team:

Chauvin Arnoux®, Inc. d.b.a. AEMC® Instruments
Phone: (800) 343-1391 • (508) 698-2115
Fax: (508) 698-2118
E-mail: techsupport@aemc.com

LIMITED WARRANTY

The Model PEL 105 is warranted to the owner for a period of two years from the date of original purchase against defects in manufacture. This limited warranty is given by AEMC® Instruments, not by the distributor from whom it was purchased. This warranty is void if the unit has been tampered with or abused, or if the defect is related to service not performed by AEMC® Instruments.

Full warranty coverage and product registration is available on our website at: www.aemc.com/warranty.html.

Please print the online Warranty Coverage Information for your records.

What AEMC® Instruments will do:

If a malfunction occurs within the two-year period, you may return the instrument to us for repair, provided we have your warranty registration information on file or a proof of purchase. AEMC® Instruments will, at its option, repair or replace the faulty material.

WARRANTY REPAIRS

What you must do to return an Instrument for Warranty Repair:

First, request a Customer Service Authorization Number (CSA#) by phone or by fax from our Service Department (see address below), then return the instrument along with the signed CSA Form. Please write the CSA# on the outside of the shipping container. Return the instrument, postage or shipment pre-paid to:

Ship To: Chauvin Arnoux®, Inc. d.b.a. AEMC® Instruments
15 Faraday Drive • Dover, NH 03820 USA
Phone: (800) 945-2362 (Ext. 360)
(603) 749-6434 (Ext. 360)
Fax: (603) 742-2346 or (603) 749-6309
E-mail: repair@aemc.com

Caution: To protect yourself against in-transit loss, we recommend you insure your returned material.

NOTE: You must obtain a CSA# before returning any instrument.



99-MAN 100427
v11 - 02/20