

Power & Energy Logger Model PEL 105



POWER & ENERGY LOGGERS

Copyright® Chauvin Arnoux®, Inc. d.b.a. AEMC® Instruments. All rights reserved.

No part of this documentation may be reproduced in any form or by any means (including electronic storage and retrieval or translation into any other language) without prior agreement and written consent from Chauvin Arnoux®, Inc., as governed by United States and International copyright laws.

Chauvin Arnoux®, Inc. d.b.a. AEMC® Instruments
15 Faraday Drive • Dover, NH 03820 USA
Tel: (800) 945-2362 or (603) 749-6434 • Fax: (603) 742-2346

This documentation is provided “as is,” without warranty of any kind, express, implied, or otherwise. Chauvin Arnoux®, Inc. has made every reasonable effort to ensure that this documentation is accurate; but does not warrant the accuracy or completeness of the text, graphics, or other information contained in this documentation. Chauvin Arnoux®, Inc. shall not be liable for any damages, special, indirect, incidental, or inconsequential; including (but not limited to) physical, emotional or monetary damages due to lost revenues or lost profits that may result from the use of this documentation, whether or not the user of the documentation has been advised of the possibility of such damages.

Statement of Compliance

Chauvin Arnoux[®], Inc. d.b.a. AEMC[®] Instruments certifies that this instrument has been calibrated using standards and instruments traceable to international standards.

We guarantee that at the time of shipping your instrument has met the instrument's published specifications.

An NIST traceable certificate may be requested at the time of purchase, or obtained by returning the instrument to our repair and calibration facility, for a nominal charge.

The recommended calibration interval for this instrument is 12 months and begins on the date of receipt by the customer. For recalibration, please use our calibration services. Refer to our repair and calibration section at www.aemc.com/calibration.

Serial #: _____

Catalog #: 2137.57 / 2137.59

Model #: PEL 105

Please fill in the appropriate date as indicated:

Date Received: _____

Date Calibration Due: _____



Chauvin Arnoux[®], Inc.
d.b.a AEMC[®] Instruments
www.aemc.com

PRODUCT PACKAGING (2137.57)



(1) Power & Energy Logger
Model PEL 105
Cat. #2137.57



(1) Large Classic Tool Bag
Cat. #2133.73



(5) Black Test Leads and Alligator Clips
Cat. #2140.73*
(*Replacement comes in Qty of 1)



(1) Power Adapter 110/240 V
w/ Power Cord
Cat. #5000.19



(12) Color-coded
ID Markers
Cat. #2140.45



(1) 5 ft USB Cable
Cat. #2140.46



(1) USB SD-Card
Adapter
Cat. #5000.45

Also Includes:

- USB Stick (DataView®/User Manual)
- 9.6 V NiMh Battery - installed
- SD-Card - installed
- High Voltage Warning/Caution Card

PRODUCT PACKAGING (2137.59)



(1) Power & Energy Logger
Model PEL 105
Cat. #2137.59



(1) Large Classic Tool Bag
Cat. #2133.73



(5) Black Test Leads and Alligator Clips
Cat. #2140.73*
(*Replacement comes in Qty of 1)



(1) Power Adapter 110/240 V
w/ Power Cord
Cat. #5000.19



(12) Color-coded
ID Markers
Cat. #2140.45



(1) 5 ft USB Cable
Cat. #2140.46



(1) USB SD-Card
Adapter
Cat. #5000.45

Also Includes:

- USB Stick (DataView®/User Manual)
- 9.6 V NiMh Battery - installed
- SD-Card - installed
- High Voltage Warning/Caution Card















(2) 24 in AmpFlex®
Model 196A-24-BK
Cat. #2140.75

Thank you for purchasing an AEMC® Instruments **Power & Energy Logger Model PEL 105**.

For the best results from your instrument and for your safety, read the enclosed operating instructions carefully and comply with the precautions for use. These products must be used by trained and qualified users only.

Symbols & Definitions

	Signifies that the instrument is protected by double or reinforced insulation
	CAUTION - Risk of Danger! Indicates a WARNING . Whenever this symbol is present, the operator must refer to the user manual before operation
	USB Socket
	Important information to acknowledge
	This product complies with the Low Voltage & Electromagnetic Compatibility European directives (73/23/CEE & 89/336/CEE)
	The product has been declared recyclable
	Ground Earth
	SD Card
	Ethernet socket (RJ45)
	Main Power Supply Input
	The UKCA marking certifies that the product is compliant with the requirements that apply in the United Kingdom, specifically regarding Low-Voltage Safety, Electromagnetic Compatibility, and the Restriction of Hazardous Substances
	In the European Union, this product is subject to a separate collection system for recycling electrical and electronic components in accordance with directive WEEE 2002/96/EC

Definition of Measurement Categories (CAT)

CAT IV corresponds to measurements performed at the primary electrical supply (< 1000 V).

Example: primary overcurrent protection devices, ripple control units, and meters.

CAT III corresponds to measurements performed in the building installation at the distribution level.

Example: hardwired equipment in fixed installation and circuit breakers.

CAT II corresponds to measurements performed on circuits directly connected to the electrical distribution system.

Example: measurements on household appliances and portable tools.



Precautions Before Use

This instrument complies with safety standard IEC 61010-2-030, the leads comply with IEC 61010-031 for voltages of 1000 V in measurement CAT III or 600 V in measurement CAT IV, and the current sensors comply with IEC 61010-2-032.

Failure to observe the safety instructions may result in electric shock, fire, explosion, destruction of the device, or destruction of the installations.

- The operator and responsible authority must read and understand all precautions needed before using the instrument. This instrument requires the user to have knowledge and awareness of electrical hazards.
- Observe the conditions of use, including temperature, relative humidity, altitude, pollution degree, and location of use.
- Do not use the instrument if it appears damaged, incomplete, or improperly closed.
- Before each use, check the condition of the insulation on the leads, housing, and accessories. Any items with a degree of deteriorated insulation must be set aside to repair or discard.
- All troubleshooting and calibration checks must be performed by competent, accredited personnel.

Front Panel

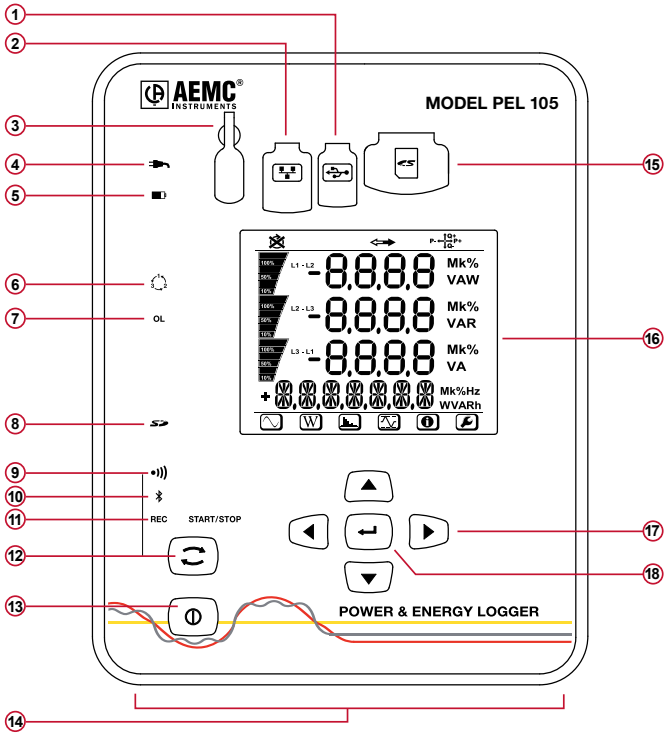

①	USB Port
②	Ethernet Port
③	Power Input
④	External Power LED (Green) <ul style="list-style-type: none"> ▪ ON: Instrument is currently running on external AC power. ▪ OFF: Instrument is running on battery or phase power.
⑤	Battery LED (Yellow/Red) <ul style="list-style-type: none"> ▪ ON: <ul style="list-style-type: none"> • Steady yellow: battery is actively charging. • Blinking yellow (once per second): battery is recovering from a full discharge. • Blinking red (twice per second): Battery is low and there is no external AC power connected. ▪ OFF: Battery is fully charged.
⑥	Phase Sequence (Red) <ul style="list-style-type: none"> ▪ ON (blinks once per second): Phase rotation not as expected ▪ OFF: Phase rotation order is as expected

7	<p>Overload LED (Red)</p> <ul style="list-style-type: none"> ▪ ON: At least one input is overloaded, or current inputs are mismatched. ▪ OFF: No input overload.
8	<p>SD Card LED (Red/Green/Orange)</p> <ul style="list-style-type: none"> ▪ Steady red: SD card is locked, unrecognized, or not present. ▪ Blinking red: SD card is initializing. ▪ Blinking orange: SD card is full. ▪ Steady green: SD card is present, recognized, and unlocked. ▪ Blinking green: SD card will be full before the end of the in-progress or pending recording.
9	<p>Wi-Fi LED (Green)</p> <ul style="list-style-type: none"> ▪ ON: <ul style="list-style-type: none"> • Steady: Wi-Fi is enabled but not currently transmitting • Blinking: Wi-Fi is enabled and transmitting. ▪ OFF: Wi-Fi is disabled.
10	<p>Bluetooth (Blue)</p> <ul style="list-style-type: none"> ▪ ON: <ul style="list-style-type: none"> • Steady: Bluetooth is enabled but not currently transmitting. • Blinking: Bluetooth is enabled and transmitting. ▪ OFF: Bluetooth is disabled.
11	<p>Recording (Green)</p> <ul style="list-style-type: none"> ▪ Blinks twice every 5 seconds when recording. ▪ Blinks once every 5 seconds when not recording.
12	<p>Control Button</p> <ul style="list-style-type: none"> ▪ Starts or stops a data recording session. ▪ Enables or disables Bluetooth. ▪ Enables or disables Wi-Fi. ▪ When pressed and held down simultaneously with the Power button ① for 2 seconds, enables/disables the line voltage power feature.
13	<p>Power Button</p> <ul style="list-style-type: none"> ▪ Turns the instrument ON or OFF when running on battery power. ▪ Glows green when the instrument is running on phase voltage power. ▪ When not glowing, indicates the phase voltage feature is enabled but the instrument is running on external AC or battery power. ▪ Blinks red when the phase voltage power feature is disabled.
14	<p>Input Terminals</p>
15	<p>SD Card Slot</p>

⑩	LCD Screen
⑪	Directional Buttons (Up, Down, Left, Right)
⑫	<p>Enter Button</p> <ul style="list-style-type: none"> ■ In Configuration mode, selects a parameter for editing. This initiates the edit mode. Pressing this button again saves the modification. ■ In Measurement mode, displays additional information for some measurement screens. ■ In Energy mode, displays partial energy data. ■ In all other modes, this button is inactive.

Turning the Instrument ON/OFF

The instrument can operate on three different sources of power:

- External power provided by plugging into an AC outlet with the AC adapter.
 - The instrument will always run on external AC power when plugged in, even if phase voltage power and/or battery power are also available.
- Phase power provided through line voltage at the terminals.
 - If AC wall power is disconnected, the instrument runs on phase voltage power if it is available and enabled.
- Battery backup power.
 - If neither external AC power nor phase voltage is available, the instrument runs on battery power.

Turning the Instrument ON

- On AC power or phase voltage power, the instrument automatically turns **ON** when you connect it.
- On battery power, you must press ⑬ for two seconds to turn **ON** the instrument.

Turning the Instrument OFF

The procedure for turning **OFF** the instrument depends upon the power source.

- AC power (indicated when the  LED is lit): Unplug the AC power adapter, and then press ⑬ for two seconds. When all LEDs light up simultaneously, release ⑬.
- Phase voltage power (indicated when ⑬ glows green): Disconnect the voltage terminal leads from the instrument, then press ⑬ for two seconds and release it when all LEDs light up simultaneously.
- Battery power: Press ⑬ for two seconds and release it when all LEDs light up simultaneously.

Installing DataView®



NOTE: DO NOT connect the instrument to the computer before installing the software and drivers.

1. Insert the DataView® thumb drive into an available USB port (wait for driver to be installed).
2. If Autorun is enabled, an AutoPlay window appears on your screen. Click “Open folder to view files” to display the DataView folder. If Autorun is not enabled or allowed, use Windows Explorer to locate and open the USB drive labeled “DataView.”
3. When the DataView folder is open, find the file Setup.exe in the USB drive root directory and double-click it to run the installation program.
4. The DataView® setup screen appears. In the upper left section of the screen, choose the language for the setup program UI. Then select DataView in the Options list and click Install.
5. Click OK at the Confirm Setup screen. The InstallShield Wizard welcome screen appears. The InstallShield Wizard leads you through the installation process. As you complete these screens, be sure to click Power Energy Logger when prompted to select the Control Panels to install.
6. When you have completed all screens, click Finish to leave the InstallShield Wizard. Then close the DataView® Setup screen. The DataView folder now appears on your computer desktop, within this folder is the PEL Control Panel



icon.

Connecting to the Computer

Before you can use the PEL Control Panel to communicate with your PEL 105, you must establish a connection between the instrument and the computer. There are six types of connections available:



- USB cable connection
- Bluetooth wireless connection
- Wi-Fi direct connection
- Ethernet point-to-point cable connection
- Network connection via LAN or Wi-Fi
- Network connection via IRD server

To begin, ensure that you have installed DataView® with the PEL Control Panel. Also ensure that the required communication and connection drivers are installed on your computer. These drivers are installed as part of the DataView® installation process.

USB

1. Plug one end of the supplied cable into the instrument, and the other end into an available USB port on the computer. The first time the instrument is connected via USB, drivers will be installed. Wait for the drivers to finish installing before proceeding.
2. With the instrument connected, open the PEL Control Panel by clicking the  icon in the DataView folder on your computer's desktop.
3. In the menu bar at the top of the screen, select Instrument.
4. In the drop-down menu that appears, click the option Add an Instrument. This opens the Add an Instrument Wizard dialog box.
5. Select USB as the connection type, and complete the Add and Instrument dialog. If you need assistance, press the Help button.

Bluetooth



To use this feature to connect to a computer, Bluetooth must be enabled on the instrument. Check the Bluetooth  LED. If it is OFF, press  and hold it down until the  LED lights up. Then, release the button to enable Bluetooth.

Your computer must also be Bluetooth-enabled. When the computer is Bluetooth-ready, connect the instrument as follows:

1. Open the Bluetooth Devices dialog on your computer to pair the instrument with your computer. Different operating systems have different steps for opening this dialog, so consult your computer's documentation for instructions.
2. When the dialog is displayed, click Add a Device. A dialog box appears listing the locally available Bluetooth devices.
3. Find the instrument, which will appear listed by its Bluetooth name. This name consists of the prefix "PEL 105" plus any additional characters you add via the PEL Control Panel. Click the name.
4. You are prompted to enter a pairing code, which for PEL 105 instruments is always 0000. After you enter the code, click Next.
5. A screen appears informing you that the instrument has been successfully connected with the computer. Click Close to exit the screen.
6. Open the PEL Control Panel. In the menu bar at the top of the screen, select Instrument.
7. In the drop-down menu that appears, click the option Add an Instrument. This opens the Add an Instrument Wizard dialog box.
8. Select Bluetooth as the connection type, and complete the Add and Instrument dialog. If you need assistance, press the Help button.

Wi-Fi Direct Connection

Before you can connect through the PEL Control Panel, you must create a Wi-Fi connection between the computer and instrument in Microsoft Windows. A direct Wi-Fi connection requires the instrument's SSID number and (if required) password, which you can define by connecting the instrument via USB cable, opening the Control Panel, and displaying the Configure dialog box, as instructed by the Control Panel Help. The Configure dialog box includes fields for setting Wi-Fi connection options.

In addition, Wi-Fi must be enabled on the instrument to use this feature. Check the Wi-Fi  LED. If it is glowing steadily or blinking, Wi-Fi is enabled. If it is OFF, press  and hold it down until the  LED lights up. Then release the button to enable Wi-Fi. Your computer must also be Wi-Fi-enabled.

When you have completed these tasks, open the PEL Control Panel and proceed as follows:

1. In the menu bar at the top of the screen, select Instrument.
2. In the drop-down menu that appears, click the option Add an Instrument.
3. Select Wi-Fi direct as the connection type, and complete the Add and Instrument dialog. If you need assistance, press the Help button.

Point-to-Point Ethernet Cable

To connect via point-to-point Ethernet, your computer must be equipped with an available Ethernet port. You must also have an Ethernet cable (purchased separately).

1. Plug one end of the Ethernet cable into the instrument, and the other end into the Ethernet port on the computer.
2. With the instrument connected, open the PEL Control Panel.
3. In the menu bar at the top of the screen, select Instrument.
4. In the drop-down menu that appears, click the option Add an Instrument. This opens the Add an Instrument Wizard dialog box.
5. Select Point-to-point Ethernet cable (APIPA mode) as the connection type, and complete the Add and Instrument dialog. If you need assistance, press the Help button.

Ethernet Network via LAN or Wi-Fi

For this type of connection, the instrument must be connected to a network accessible to the computer. The network connection can be either via LAN or Wi-Fi router. Consult your network administrator if you need assistance with this. When this connection is established, open the PEL Control Panel and do the following:

1. In the menu bar at the top of the screen, select Instrument.
2. In the drop-down menu that appears, click the option Add an Instrument.
3. Select Ethernet (LAN or Wi-Fi) as the connection type, and complete the Add and Instrument dialog. If you need assistance, press the Help button.

Network via IRD Server



An IRD server allows you to connect your computer to instruments on different networks. You must first connect the instrument to a network that can access the internet. Consult your network administrator if you need assistance with this. When this connection is established, open the PEL Control Panel and do the following:

1. In the menu bar at the top of the screen, select Instrument.
2. In the drop-down menu that appears, click the option Add an Instrument.
3. Select IRD server as the connection type, and complete the Add and Instrument dialog. If you need assistance, press the Help button.
4. A screen appears informing you that the instrument has been successfully connected with the computer. Click Close to exit the screen.
5. Open the PEL Control Panel. In the menu bar at the top of the screen, select Instrument.
6. In the drop-down menu that appears, click the option Add an Instrument. This opens the Add an Instrument Wizard dialog box.
7. Select Bluetooth as the connection type, and complete the Add and Instrument dialog. If you need assistance, press the Help button.

Installing the SD-Card

Data recording sessions are stored in the included 8 GB SD card, which also accepts FAT32 SDHC cards up to 32 GB capacity. If the SD card is unformatted, you will need to format it before use. Formatting can be done through a Microsoft Windows command or through the DataView® PEL Control Panel.

To install the SD card:

1. Locate the card slot on the front panel.
2. Ensure that the write-protect sliding tab on the card is in the “unlock” position (towards the metal contacts).
3. Insert the SD card into the slot, with the metal contacts facing up (towards the top of the instrument).
4. Press the SD card into the slot until it clicks in place.
5. Press the attached cap into the card slot to ensure water resistance.
6. If the SD Card is not formatted, the  LED glows red. To format the installed card, open the PEL Control Panel. Click Instrument in the menu bar and select Configure. Then click Format SD-Card in the General tab of the Configure Instrument dialog box, and click Yes to confirm.
7. When the card is installed and ready for use, the  LED glows steady green. To remove a card, press down on it until the card unclicks. It will pop up, allowing you to pull it from the slot.

Setting the Instrument Clock

Before using the instrument, you should ensure the instrument clock is set to the correct time zone. By default the PEL 105 is set to Universal (UTC) time. To change this to another time zone, do the following:

1. Open the PEL Control Panel and connect to the instrument, as instructed in the preceding section “Connecting to the Computer.”
2. Select Instrument in the menu bar, and select Configure. This opens the Configure dialog box.
3. In the General tab, click the Set Clock button to display the Date/Time dialog box.
4. You can synchronize the instrument’s clock with the computer’s clock, or use the Date and Time fields to select another date and time. You can click the Set Time Zone field to select a time zone adjustment. This defines the number of hours by which the instrument’s local time differs from UTC time. For example, if you set the adjustment to -4, the PEL 105 will display its local time as 4 hours “behind” UTC (e.g. when local time is 12:00 PM, UTC is 4:00 PM)



NOTE: This adjustment also applies when you select Synchronize with PC Clock.

When you do this:

- The Control Panel reads your computer’s time and time zone information.
 - The time is converted to UTC.
 - The instrument’s UTC time is set to the computer’s UTC time.
 - The time zone adjustment is applied to the UTC time to derive the instrument’s local time.
5. Complete the Date/Time dialog box and click OK. Then click OK in the Configure dialog box to set the clock on the instrument.

Starting and Stopping a Recording





Before starting a recording, ensure that the instrument is not currently locked (the word LOCK appears on the screen in Configuration mode). The instrument cannot begin a recording when it is locked. The instrument is locked when:

- Being configured via the PEL Control Panel.
- Disabled through an option in the PEL Control Panel.
- A recording session is already in progress. Note that in this case the  button remains active so you can stop the recording. However, you cannot start a new recording if one is in progress.

If any of these situations is in effect, take appropriate action as necessary to unlock the instrument. Then check the SD card  LED.

- If the LED is green, the SD card is ready to store recordings.
- If the LED glows steady red, ensure that:
 - The SD card is installed.
 - The write-protect sliding tab on the card is in the “unlock” position (towards the metal contacts).
 - The SD card is formatted. Formatting can be performed either through the PEL Control Panel, or through a Windows command on your computer.
- If the LED blinks orange, the SD card is full. Download any data you want to save to your computer, then erase the content of the card through the PEL Control Panel.

When the  LED indicates the SD card is ready, you can begin recording. To do this through the PEL Control Panel, follow the instructions provided in the PEL Control Panel Help system. To record through the instrument user interface, do the following:

1. Press  and hold it down until the **REC** LED lights. Then release .
2. The **REC** LED should now blink twice every five seconds, indicating a recording is in progress.
3. To stop a recording, press  and hold it down until the **REC** LED lights up, then release .

To view the recording session, connect the instrument to your computer running the PEL Control Panel, open the Help system, and follow the instructions for downloading and viewing recordings.

Distribution Systems and Hook-ups

The following hookup diagrams and connection instructions are for distribution systems supported by the PEL 105. The instrument must be appropriately configured for the hookup type. Most configuration is performed through the PEL Control Panel, as described in the Help. Some configuration can also be done via the instrument's front panel, as described in the user manual. Ensure that the current arrow on the sensor is directed towards the load. This ensures proper phase angle for power measurements and other phase-sensitive measurements.

Single Phase 2-Wire (1P-2W)

- VN test lead to neutral (N)
- VE/GND test lead to ground (optional)
- V1 test lead to L1
- IN probe to neutral (optional)
- I1 probe to L1

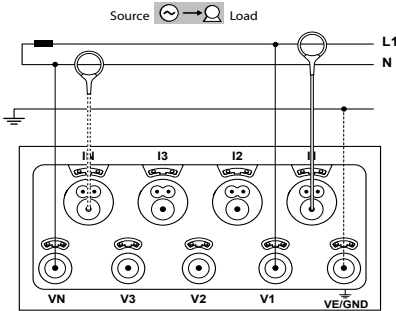

Single Phase 3-Wire (1P-3W)

- VN test lead to neutral (N)
- VE/GND test lead to ground (optional)
- V1 test lead to L1
- V2 test lead to L2
- IN probe to neutral (optional)
- I1 probe to L1
- I2 probe to L2

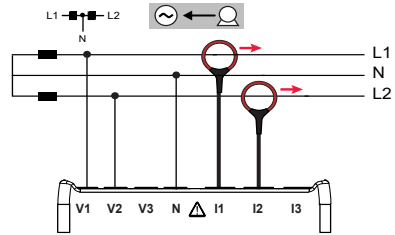

3-Phase 3-Wire Δ (2 current probes) (3P-3W Δ 2)

- VE/GND test lead to ground
- V1 test lead to L1
- V2 test lead to L2
- V3 test lead to L3
- I1 probe to L1
- I3 probe to L3

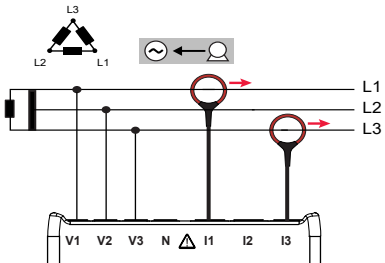

3-Phase 3-Wire Δ (3 current probes) (3P-3W Δ 3)

- VE/GND test lead to ground
- V1 test lead to L1
- V2 test lead to L2
- V3 test lead to L3
- I1 probe to L1
- I2 probe to L2
- I3 probe to L3

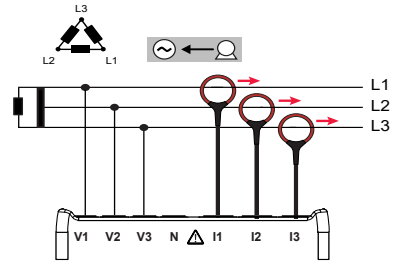

**3-Phase 3-Wire Open Δ
(2 current probes)
(3P-3WO2)**

- VE/GND test lead to ground
- V1 test lead to L1
- V2 test lead to L2
- V3 test lead to L3
- I1 probe to L1
- I3 probe to L3

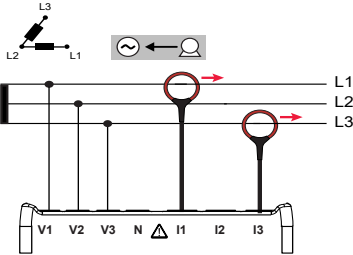

**3-Phase 3-Wire Open Δ
(3 current probes)
(3P-3WO3)**

- VE/GND test lead to ground
- V1 test lead to L1
- V2 test lead to L2
- V3 test lead to L3
- I1 probe to L1
- I2 probe to L2
- I3 probe to L3

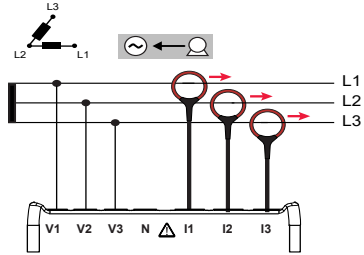

**3-Phase 3-Wire Y
(2 current probes)
(3P-3WY2)**

- VE/GND test lead to ground
- V1 test lead to L1
- V2 test lead to L2
- V3 test lead to L3
- I1 probe to L1
- I3 probe to L3

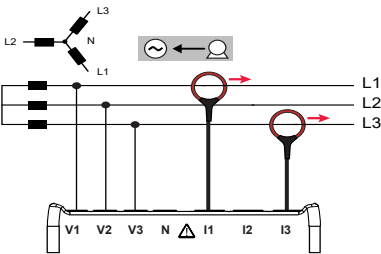

**3-Phase 3-Wire Y
(3 current probes)
(3P-3WY3)**

- VE/GND test lead to ground
- V1 test lead to L1
- V2 test lead to L2
- V3 test lead to L3
- I1 probe to L1
- I2 probe to L2
- I3 probe to L3

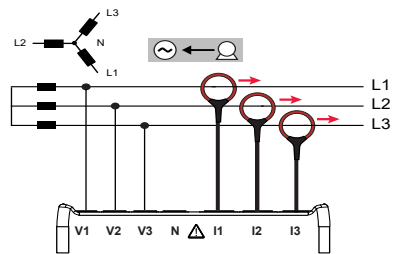

3-Phase 3-Wire Δ Balanced (1 current probe) (3P3W Δ b)

- VE/GND test lead to ground
- V1 test lead to L1
- V2 test lead to L2
- I3 probe to L3

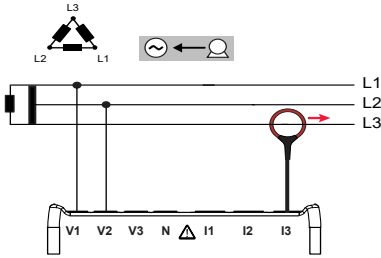

3-Phase 4-Wire Y (3P-4WY)

- VE/GND test lead to ground
- VN test lead to neutral (N)
- V1 test lead to L1
- V2 test lead to L2
- V3 test lead to L3
- IN probe to neutral
- I1 probe to L1
- I2 probe to L2
- I3 probe to L3

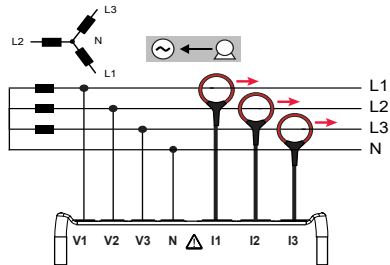

3-Phase 4-Wire Y Balanced (3P-4WYb)

- VE/GND test lead to ground
- VN test lead to neutral (N)
- V1 test lead to L1
- IN probe to neutral
- I1 probe to L1

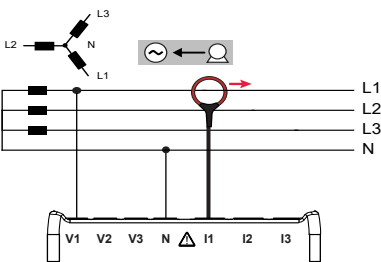

3-Phase 4-Wire Y 2½ Element (3P-4WY2)

- VE/GND test lead to ground
- VN test lead to neutral (N)
- V1 test lead to L1
- V3 test lead to L3
- IN probe to neutral
- I1 probe to L1
- I2 probe to L2
- I3 probe to L3

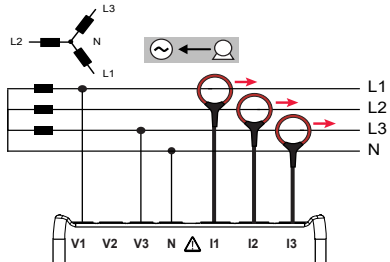

3-Phase 4-Wire Δ (3P-4W Δ)

- VE/GND test lead to ground
- VN test lead to neutral (N)
- V1 test lead to L1
- V2 test lead to L2
- V3 test lead to L3
- IN probe to neutral
- I1 probe to L1
- I2 probe to L2
- I3 probe to L3

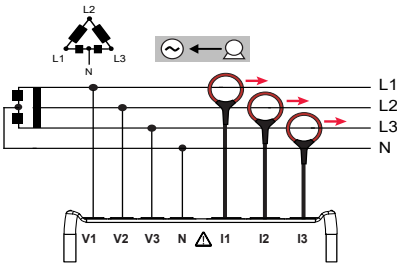

3-Phase 4-Wire Open Δ

- VE/GND test lead to ground
- VN test lead to neutral (N)
- V1 test lead to L1
- V2 test lead to L2
- V3 test lead to L3
- IN probe to neutral
- I1 probe to L1
- I2 probe to L2
- I3 probe to L3

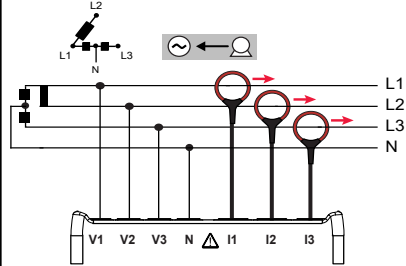

DC 2-Wire (dC-2W)

- VE/GND test lead to ground
- VN test lead to the common conductor.
- V1 test lead to conductor +1
- IN probe to the common conductor
- I1 probe to conductor +1

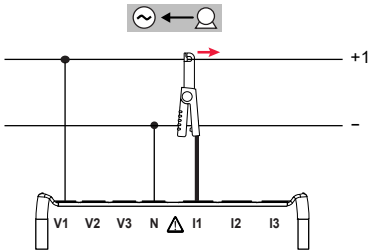

DC 3-Wire (dC-3W)

- VE/GND test lead to ground
- VN test lead to the common conductor
- V1 test lead to conductor +1
- V2 test lead to conductor +2
- IN probe to the common conductor
- I1 probe to conductor +1
- I2 probe to conductor +2

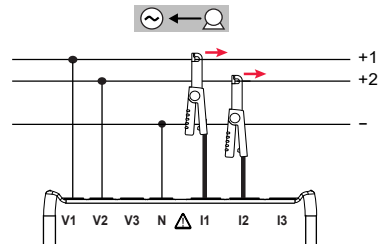

DC 4-Wire (dC-4W)

- VE/GND test lead to ground
- VN test lead to the common conductor
- V1 test lead to conductor +1
- V2 test lead to conductor +2
- V3 test lead to conductor +3
- IN probe to the common conductor
- I1 probe to conductor +1
- I2 probe to conductor +2
- I3 probe to conductor +3

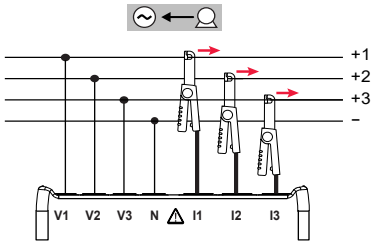

Repair and Calibration

To ensure that your instrument meets factory specifications, we recommend that it be sent back to our factory Service Center at one-year intervals for recalibration or as required by other standards or internal procedures.

For instrument repair and calibration:

You must contact our Service Center for a Customer Service Authorization Number (CSA#). Send an email to repair@aemc.com requesting a CSA#, you will be provided a CSA Form and other required paperwork along with the next steps to complete the request. Then return the instrument along with the signed CSA Form. This will ensure that when your instrument arrives, it will be tracked and processed promptly. Please write the CSA# on the outside of the shipping container. If the instrument is returned for calibration, we need to know if you want a standard calibration or a calibration traceable to N.I.S.T. (includes calibration certificate plus recorded calibration data).

Ship To: Chauvin Arnoux®, Inc. d.b.a. AEMC® Instruments
15 Faraday Drive ▪ Dover, NH 03820 USA
Phone: (800) 945-2362 (Ext. 360) / (603) 749-6434 (Ext. 360)
Fax: (603) 742-2346
E-mail: repair@aemc.com

(Or contact your authorized distributor.)

Contact us for the costs for repair, standard calibration, and calibration traceable to N.I.S.T.



NOTE: You must obtain a CSA# before returning any instrument.

Technical Assistance

If you are experiencing any technical problems or require any assistance with the proper operation or application of your instrument, please call, e-mail or fax our technical support team:

Chauvin Arnoux®, Inc. d.b.a. AEMC® Instruments
Phone: (800) 343-1391 (Ext. 351)
Fax: (603) 742-2346
E-mail: techsupport@aemc.com
www.aemc.com

Limited Warranty

The instrument is warranted to the owner for a period of two years from the date of original purchase against defects in manufacture. This limited warranty is given by AEMC® Instruments, not by the distributor from whom it was purchased. This warranty is void if the unit has been tampered with, abused, or if the defect is related to service not performed by AEMC® Instruments.

Full warranty coverage and product registration is available on our website at www.aemc.com/warranty.html

Please print the online Warranty Coverage Information for your records.

What AEMC® Instruments will do:

If a malfunction occurs within the warranty period, you may return the instrument to us for repair, provided we have your warranty registration information on file or a proof of purchase. AEMC® Instruments will repair or replace the faulty material at our discretion.

REGISTER ONLINE AT: www.aemc.com/warranty.html

Warranty Repairs

What you must do to return an Instrument for Warranty Repair:

First, send an email to repair@aemc.com requesting a Customer Service Authorization Number (CSA#) from our Service Department. You will be provided a CSA Form and other required paperwork along with the next steps to complete the request. Then return the instrument along with the signed CSA Form. Please write the CSA# on the outside of the shipping container. Return the instrument, postage or shipment pre-paid to:

Chauvin Arnoux®, Inc. d.b.a. AEMC® Instruments
15 Faraday Drive, Dover, NH 03820 USA
Phone: (800) 945-2362 (Ext. 360) / (603) 749-6434 (Ext. 360)
Fax: (603) 742-2346
E-mail: repair@aemc.com

Caution: To protect yourself against in-transit loss, we recommend that you insure your returned material.



NOTE: You must obtain a CSA# before returning any instrument.

Quick Start Guide Translations

Visit our website to view and download a PDF version of this Quick Start Guide:

Español





06/23
99-MAN 100428 v09

AEMC[®] Instruments
15 Faraday Drive • Dover, NH 03820 USA
Phone: (603) 749-6434 • (800) 343-1391 • Fax: (603) 742-2346
www.aemc.com
